

VACUUM TUBE VALLEY™

Issue 11
Spring 1999

The Classic Electronics Reference Journal

Published Quarterly
Price \$9.00

Driver of Choice: The 6SN7

Mid Priced Vintage Hi-Fi
Classic Components on a Budget

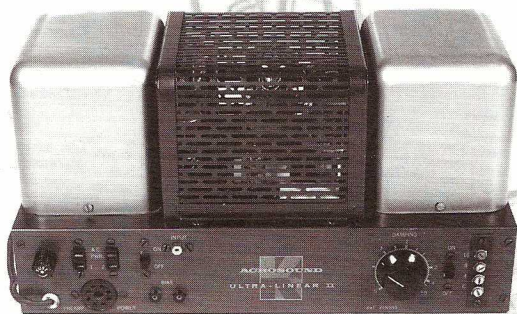

VTV Octal Line Stage
Simple, Accurate, and Sensual

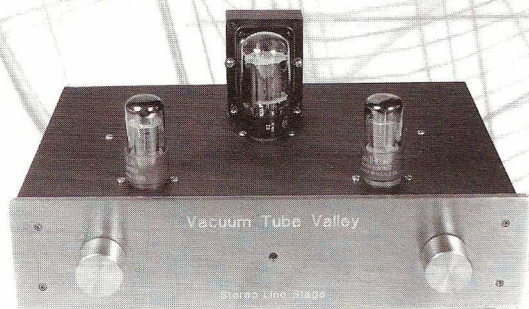

ASUSA A-4 Kit Review
High Quality Kits Are Back



Visit us on the web
www.vacuumtube.com

**VTV Issue # 11
Table of Contents:**

- 6SN7 Driver of Choice..... 3**
- Listening to 6SN7s..... 9**
- Octal Line Stage Project..... 10**
- Richardson Electronics..... 11**
- Mid-Priced Vintage Hi-Fi..... 14**
- Computing with Tubes..... 20**
- Tube Dumpster: 6688..... 21**
- ASUSA A-4 Kit Review.....22**
- OTL Headphone Amp..... 24**
- VTV Listens to Capacitors... 26**
- Vintage Speakers in Japan 27**
- Test Bench: Power Supplies 28**
- FREDs and Schottkys..... 31**

**2/27-28/99 Southern California
Tube Enthusiast Weekend a Success**

There was a good showing at the VTV Tube School with several industry professionals in attendance. The Hi-Fi Swap on the following day was attended by about 1000 enthusiasts who found lots of tube gear, NOS tubes and parts. A great time was had by all!

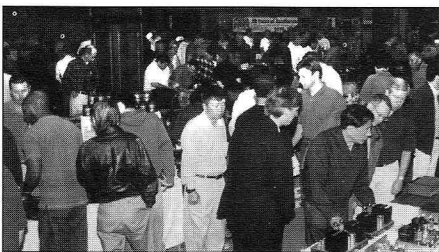

New tubes from Sovtek

New Sensor Corporation, New York, New York has recently introduced a number of tubes for the guitar amplifier and hi-fi applications. Their new KT66 and KT88 have the famous "coke bottle" shape reminiscent of the classic Tung-Sol 6550. According to New Sensor's press release, improvements have been made in grid and plate materials used in their output tubes.

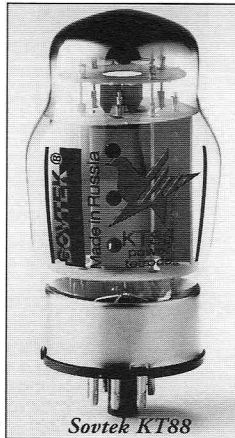

Sovtek KT88

The new Sovtek 6550 comes in two versions, the 6550WD with a plastic base and the 6550WE with the familiar metal ring base. A new, octal based, directly heated triode, the 6B4G is also available from Sovtek. It is similar in appearance to the Sovtek 300B, but has a smaller bottle, octal base and a 6.3V filament. We have also learned that New Sensor will also be introducing a new 12AX7 type in late spring or early summer 1999. Apparently, this is an improved version of earlier Sovtek 12AX7 types. For more information, contact: New Sensor Corporation, 20 Cooper Square, New York, NY 10003 1-(800) 633-5477



Sovtek 6550WE and 6B4G



Svetlana SV300B MP

New 300B from Svetlana

Svetlana Electron Devices, Huntsville, Alabama, has announced the availability of their high-quality new SV300B power triode and its beautiful new packaging. Russian engineers at Svetlana have worked hard to bring the quality construction, materials, processing, aging and classic sound to their 300B type. The plate is carbonized, high-purity nickel and the filament oxide coating duplicates the original mixture. The gold-plated control grid minimizes grid emission and improves stability. It is available as a single tube or as a Svetlana Tested and Matched Pair (pictured). For more information, contact: Svetlana Electron Devices, 8200 South Memorial Parkway, Huntsville, AL 35802 (256) 882-1344

Vacuum Tube Valley Launches New Website

VTV recently uploaded its new website: www.vacuumtube.com. Our site now gets over 7,000 visits daily! The site has many new features and products including more information on and photos of VTV back issues, new tube links, buy-sell tube classifieds, etc. We have also expanded our Pro-Tube Shop catalog online with several new parts, accessories, tube amp kits and other goodies.

Cover illustration of 6SN7 structure by Kent Leech, a talented illustrator whose hobby is tube audio. If you are interested in high quality technical illustrations, contact Kent at 925-253-9757

EDITORIAL STAFF

- Charles Kittleson** - Editor and Publisher
- John Atwood** - Technical Editor
- Eric Barbour** - Senior Editor
- Terry Buddingh** - Guitar Editor
- Steve Parr** - Art Director
- Julie P. Werner** - Copy Editor
- Website** - www.vacuumtube.com

Copyright 1999 **Vacuum Tube Valley™** and **Big Tone™** All rights reserved.

No part of this publication may be reprinted or otherwise reproduced without written permission of the publisher.

Send circulation and editorial correspondence to:

Vacuum Tube Valley
P.O. Box 691,
Belmont, California 94002 USA
e-mail triode@vacuumtube.com
ISSN # 1095-4805

Vacuum Tube Valley is published quarterly for electronic enthusiasts interested in the colorful past, present and future of vacuum tube electronics.

Subscription Rate: US\$36/year (4 issues)
US\$43/Canada & US\$66/Asia, US\$53 Europe

**US Bank Check, Credit Cards or Cash
are accepted for payment.**

**Phone - (650) 631 - 6550
FAX - (650) 654 - 2065**

6SN7: Driver of Choice

By Eric Barbour

© 1999 All Rights Reserved

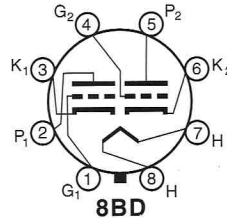

Why are we doing an article about this dual triode? It's not used in modern guitar amps, and it's not common in high-end equipment. This lack of use is not germane to its worth! The 6SN7 was a seminal audio type. First, it was the driver tube in the first American version of the Williamson amplifier. This was the first widely-used "hi-fi" amplifier design of the postwar era. Second, a good 6SN7GTB will give almost any other medium-mu triode a run for its money, in terms of linearity.

1. History

The first primitive directly-heated triodes were usually low-mu or medium-mu. Many kinds of cathodes were under development at the time, but their invention became dominant. It was a high-purity nickel tube coated with a mixture of barium and strontium oxides, binders and other agents. By inserting a wire heater into a ceramic tube (or, later and most commonly, coating it with aluminum oxide), and then slipping the heater into the nickel sleeve, the cathode could be heated to a suitable temperature to make the barium-strontium mixture emit electrons into the vacuum. The optimum surface temperature was found to be about 900-1100 degrees Celsius.

A major advantage of this scheme: the heater could be run from low-voltage AC,

with minimum hum induction into the audio or radio circuit (especially in the critical detector stage of a TRF or superhet receiver). A side benefit was that plenty of electrons were emitted by the oxide mixture, as much as an oxide-coated filament. Result: good efficiency and low hum, plus a cathode that could be connected to its own bias resistor, allowing the tube to self-bias and eliminating the "C" bias supply.

The Uni-potential indirectly heated cathode is credited to A.M. Nicolson of Western Electric and was first made in 1914. Its patent was applied for in 1915 and was issued in 1923. Its successor was the McCulloch/Kellogg 401 (1925). It was a plug-in replacement for the common 201-A triode, except with AC heater



6N7G

connections on a top cap. Thus, it could be plugged directly into an older TRF radio that used 201-As, while allowing operation of the heaters from an external filament transformer, and eliminating the "A" battery. Marathon, Sovereign, Cardon/Sparton and Arcturus made similar triodes during the 1926-28 period.

The Brits were a bit late here. Prominent engineer H. J. Round developed a similar cathode around 1922. Round's AC triode had space as the insulator between the bright emitter tungsten heater and the the cathode. This slow-warmup version was first developed into a product by MOV engineer C. W. Stropford and used in their KL1 triode (1927). However, the Stropford cathode's heater was wrapped around a silica rod and was not in direct contact with the nickel tube. Met-Vick engineer E. Yeoman Robinson produced a slip coated heater and nickel tube assembly which was a quick warm-up type. It was first used in Met-Vick's AC/R and AC/G triodes(1927). MOV later bought in this design and re-numbered it KH1, abandoning the KL1 and Round's design.

Standardization arrived with RCA's UY-227 (1927). Its design, and its five-pin base, became industry norms. The 227 was the father of all subsequent medium-gain triodes. Although used only as detector/audio preamp stages at first, it became critical to the development of television, radar, computers and a wide range of other electronic applications. A problem with RCA's ceramic cathode was an electrochemical reaction with the tungsten heater. The 2.5V early heater standard was a fix, but heavy heater current was a disadvantage. Of all the 27s around in the late 1920s, the Arcturus was thought

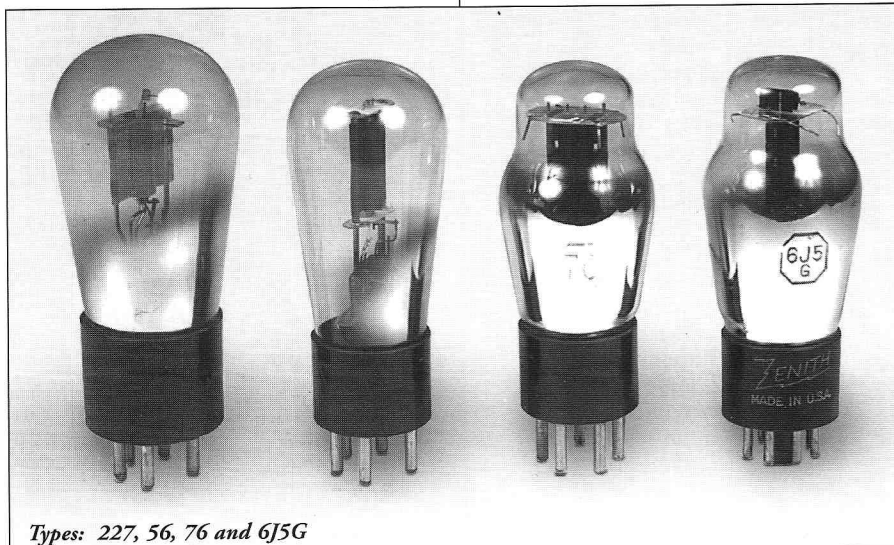

Types: 227, 56, 76 and 6J5G

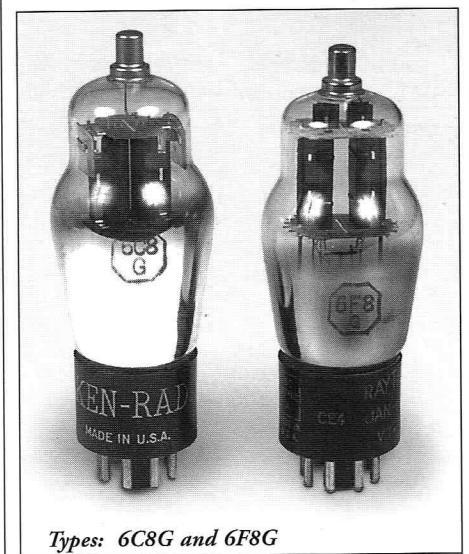

Types: 6C8G and 6F8G

6 S N 7 : D R I V E R O F C H O I C E

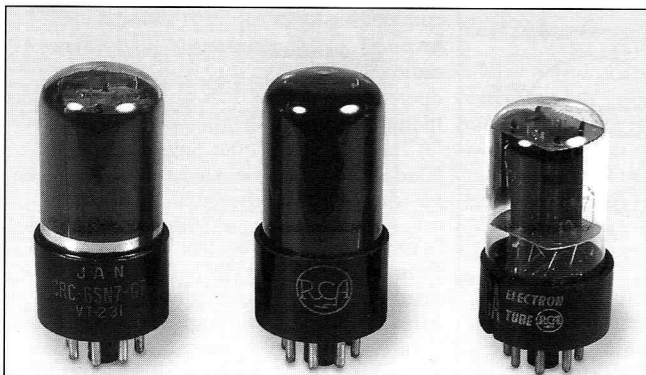

RCA 6SN7GT/VT-231 (1940s), 6SN7GT (1940s), 6SN7GTB (1960s)

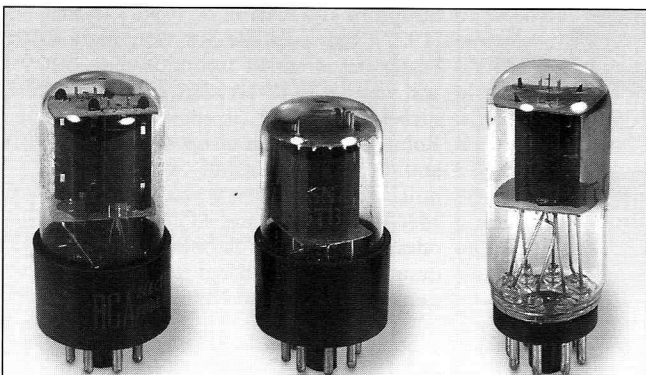

RCA 6SN7GTA (1960), GE 6SN7GTB (1960s), RCA 6SN7GTB (1975)

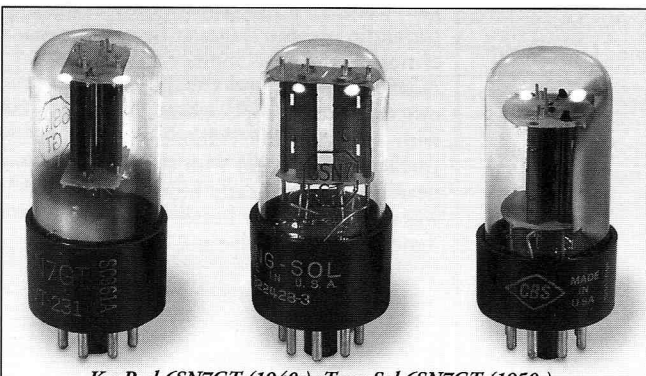

KenRad 6SN7GT (1940s), Tung-Sol 6SN7GT (1950s), CBS 6SN7GTB (1950s)

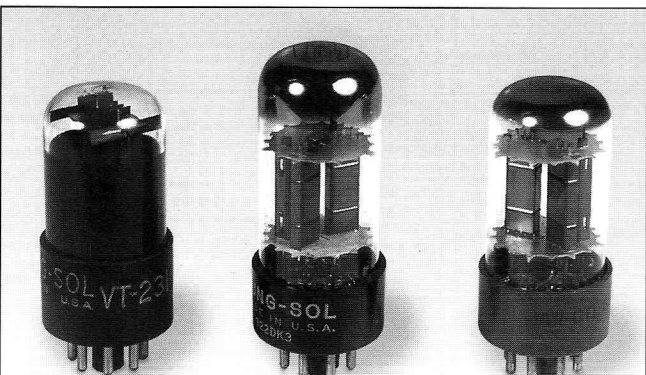

Tung-Sol VT-231 (1945s), 6SN7GTB (1950s), 6SN7WGTB (1960s)

to be the best for quick heating and low hum.

The UY-227 led to the 27 and 37 (1932), which led to the 56 and the 76 (both 1932). The first such tube to use a 6.3V heater, the National Union NY67 (1931), did not enjoy as much success as the later type 76 did. The 6.3V figure was chosen to work off the extant automotive batteries (a typical lead-acid cell produces 2.1 volts when fully charged, and car batteries of the day had three cells). It became the most popular standard for parallel heater connections, even in radios not used in a car. To this day, "filament" transformers are made with secondaries in multiples of the same 6.3v figure—even though they usually run solid-state electronics nowadays, and not tube heaters.

The 56 and 76 were slowly pushed aside by the new-fangled octal base. It allowed many more connections to more complex tubes, setting the stage for multiple triodes and the like. RCA's 6C5 (1935) was the first octal triode. Early metal 6C5s were apparently just triode-connected 6J7 pentodes. Tung-Sol introduced the similar 6P5G (1936) as a competitor. Tungram in Europe made a 6C5G with a true triode assembly a little later. Neither one was especially popular, since high-gain tetrodes and pentodes were much more useful in stages of a receiver other than the audio detector.

RCA's 6J5 (1937) enjoyed much more popularity, pushing aside the 6C5 in consumer equipment. It was also used in military equipment from World War II until the 1980s.

Shortly thereafter came the first medium-mu DUAL triode for small-signal use: RCA's 6F8G (late 1937). It had the grid of one triode connected to a top cap, apparently because radio engineers wanted to keep the detector stage's grid as far away from the AC heater power as possible. A similar type, with higher mu, was the RCA 6C8G (1937). Although the 6C8G was used in the first electronic computer, ABC, (see VTV #7 pp 28-30) these first octal duals were not big successes in other areas.

A peculiar development of 1938 was the National Union 6AE6. It contained two very different triodes, one having a variable-mu grid. It was designed to drive the 6AD6 eye tube directly in a radio circuit. Variable-mu tubes are unsuitable for high-fidelity use because of their high distortion.

There were dual triodes long before the 6F8G. These were usually special power triodes of one type or another. One major line, which died out after WWII, was the Class-B push-pull dual triode family. It started with the 19 (1933) and went through many variations to the 6N7 (1936). Also predating the 6F8G were the many duals which had a driver triode and an output triode in the same envelope. Usually they were intended for direct coupling, with the power triode being designed for zero-bias operation. This included the Speed Triple-Twin and the 6AC6. We will go into high-mu triodes such as the 6SL7 in a future article; they came later than medium-mu types.

The 6F8G's child enjoys massive success, and is still being manufactured and used in new designs at the end of the millennium. RCA's 6SN7GT (introduced late 1939, officially registered with RMA 1941) was the right package at the right time. The grid cap was eliminated, as radio engineers realized that it was not really needed. It and the cognate 12SN7GT saw wide use in military equipment during the war.

6SN7GT Ratings Escalation

Type	V _{pmax}	Diss (per triode)
GT (1939)	250v	2.5w
GTA (1948)	450v	5.0w
*GTB (1952)	450v	5.0w

*(controlled warmup version)

6 S N 7 : D R I V E R O F C H O I C E

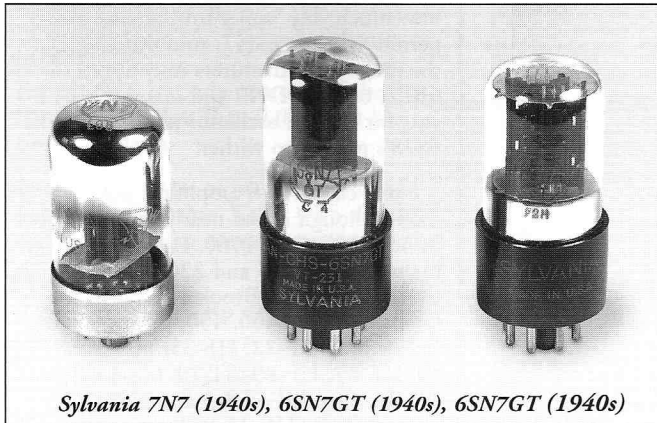

Sylvania 7N7 (1940s), 6SN7GT (1940s), 6SN7GT (1940s)

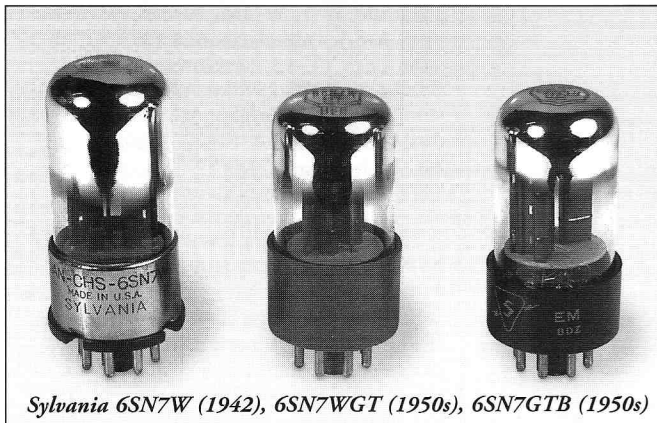

Sylvania 6SN7W (1942), 6SN7WGT (1950s), 6SN7GTB (1950s)

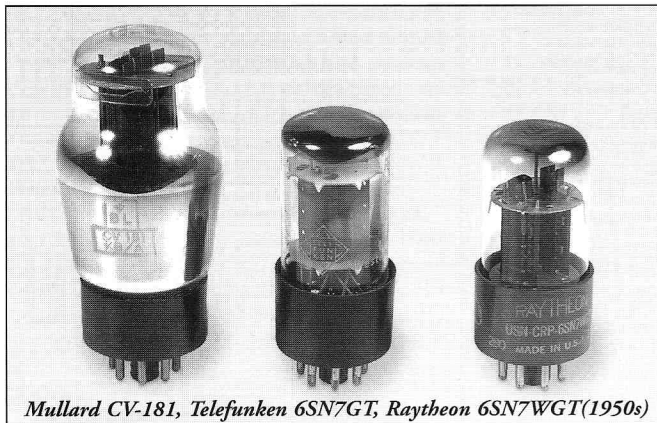

Mullard CV-181, Telefunken 6SN7GT, Raytheon 6SN7WGT(1950s)

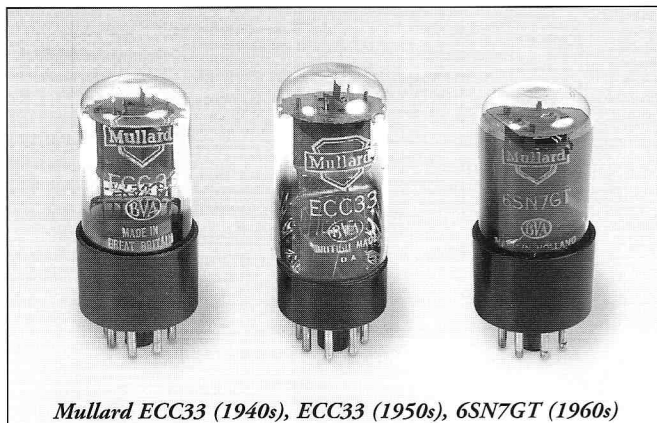

Mullard ECC33 (1940s), ECC33 (1950s), 6SN7GT (1960s)

Special versions of the 12SN7GT were made for low-plate-voltage operation in battery and aircraft radios. These were often run from 26 volts, which was available from aircraft magnetos. To save the bother and maintenance headaches of using a dynamotor or vibrator to boost the voltage, many low-voltage tubes appeared. Aside from RF pentodes and beam-power types, this series included the Tung-Sol 6AH7GT and 12AH7GT (1941) and, after the war, RCA's 12SX7GT (1946).

Sylvania was a determined competitor to RCA, and pushed their Loktals types hard. Even so, Loktals did not become standards to the same extent as the octal tubes. One of the first Loktals was the 7A4 (1939). Like many other Loktals, it was a blatant copy of a pre-existing octal tube (6J5). The 6SN7 copy was the 7N7 (1940). Both appeared in 12-volt heater versions, as 14A4 and 14N7. The 7A4 and 14N7 were also available in special low-capacitance versions, XXL and XXD.

Mullard introduced the ECC30 series during WW2. The ECC31 came first, then the ECC32. The ECC31 is electrically the same as the ECC32, but has a common cathode. No ECC30 series are exactly equivalent to American 6SN7s, but there are some similarities. This includes the ECC33 (the μ is

35, not 20 like the 6SN7, however). The ECC32 (made by Mullard with the ST-shape) was used in early Lowther amplifiers, but otherwise, was an industrial triode, like the ECC31. The ECC32 and ECC35 were used by Pye and Leak, but no audio use of the ECC34 was known.

6SN7 variants included the British military CV181 and CV1988, plus the long-defunct MOV B65. There are a number of B65s branded by Osram or GEC, but they were all made by MOV if British. Note that the B65 has a unique structure and is not exactly a 6SN7. The CV181 appears to be the only member of the 6SN7 family to appear in an ST-shape envelope with a shoulder. 6SN7s were manufactured in Russia and China under the Russian designator 6N8S (looks like 6H8C, because it is in Cyrillic lettering). Manufacture of 6SN7s has been confirmed in Italy, France, Holland (by Philips), Australia, Germany, Japan, India, various countries in Eastern Europe, and even in South America. The original late 1940s British Williamson amplifiers used either an MOV L63 (6J5G) or the B65 as driver tubes.

After WWII, television and high fidelity came into the fore. Since low distortion was needed for both hi-fi and for the vertical oscillator circuits in TV sets, the 6SN7 saw some duty in both worlds. In fact, a 1958 article (see ref. 5 below) demonstrated that the 6SN7GTB was superior to the 12AU7 as a power tube driver in hi-fi amps. The 6CG7 (RCA 1954) was touted as a 9-pin equivalent of the 6SN7. It is notable in having an electrostatic shield separating the two sections. The later and more common 6FQ7 eliminated the shield, probably to cut costs. CBS-Hytron came out with the 12BH7 in 1950 as a higher transconductance 9-pin version of the 6SN7. Although eclipsed by the 6FQ7 later, this higher perveance version re-surfaced in the 1960s as a 6-volt version: the 6GU7, intended for color TV sets.

The only premium version of the 6SN7 to be made for critical applications in the USA is believed to be RCA's 5692 (1948), a member of the "Special Red" line. Intended for avionics and military applications, the 5692 was deliberately underrated to maximize its lifetime (provided the engineer stuck to the ratings). RCA may have developed this tube, yet it seems that GE actually manufactured it for them under contract. The distinctive red base is apparently unique to GE production. Many other firms (including Raytheon, CBS/Hytron, and Rogers in Canada) made their own 5692s, but always with

Brimar CV-1988 (1950s clear), Brimar CV-1988 (1972 tall), MOV B65 (1950s)

RCA JAN 5692 (1950s), RCA 5692 (1950s), CBS 5692 (1950s)

GE 6SN7 GTA/GTB Data Sheet (1954)

6SN7-GTB
6SN7-GTA
12SN7-GTA
ET-T899
Page 3
10-54

CHARACTERISTICS AND TYPICAL OPERATION

CLASS A₁ AMPLIFIER, EACH SECTION

Plate Voltage90	250	250 Volts
Grid Voltage0	-12.5	-8 Volts
Amplification Factor20	20	20
Plate Resistance, approximate6700	7700	7700 Ohms
Transconductance3000	2600	2600 Micromhos
Plate Current10	1.3	9.0 Milliamperes
Grid Voltage, approximate-7	-18	-18 Volts
I _b = 10 Microamperes			

* Heater warm-up time is defined as the time required in the circuit shown at the right for the voltage across the heater terminals to increase from zero to the heater test voltage (V). For this type, E=25 volts (RMS or DC), V₁=5.0 volts (RMS or DC), and R=31.5 ohms.
† Without external shield.

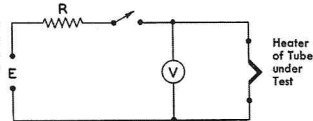

‡ For operation in a 525-line, 30-frame television system as described in "Standards of Good Engineering Practice Concerning Television Broadcast Stations," Federal Communications Commission. The duty cycle of the voltage pulse must not exceed 15 percent of one scanning cycle.

§ Value given is to be considered as an Absolute Maximum Rating. In this case, the combined effect of supply voltage variation, manufacturing variation including components in the equipment, and adjustment of equipment controls should not cause the rated value to be exceeded.
¶ In stages operating with grid-leak bias, an adequate cathode-bias resistor or other suitable means is required to protect the tube in the absence of excitation.

CLASS A RESISTANCE-COUPLED AMPLIFIER

EACH SECTION											
R _p	R _g	R _{g1}	E _{bb} = 90 Volts	E _{bb} = 180 Volts	E _{bb} = 250 Volts	E _{bb} = 300 Volts					
Mesh.	Mesh.	Mesh.	R _k	R _k	R _k	R _k	R _k	R _k	R _k	R _k	R _k
0-10	0-10	0-10	3900	10	10	3600	11	20	3500	11	30
0-10	0-24	0-10	5000	11	14	4700	12	27	4400	12	41
0-24	0-24	0-10	9400	11	13	8700	11	25	8700	12	38
0-24	0-51	0-10	11000	11	17	11000	12	32	11000	12	48
0-51	0-51	0-10	19000	11	15	18000	12	29	18000	12	43
0-51	1.0	0-10	24000	11	19	23000	12	37	23000	12	54
0-24	0-24	10	0	14	12	0	16	20	0	17	28
0-24	0-51	10	0	14	16	0	16	29	0	17	40
0-51	0-51	10	0	14	15	0	15	26	0	16	38
0-51	1.0	10	0	14	19	0	16	35	0	16	52

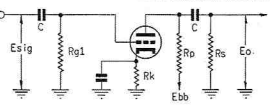

Notes: 1. E_o is maximum RMS voltage output for five percent (5%) total harmonic distortion. 2. Gain measured at 2.0 volts RMS output. 3. For zero-bias data, generator impedance is negligible.

brown Micanol bases. The 5692 was made in Sweden by Standard Electric as the 33S30. This tube was not widely used (and NEVER in audio, until the 1980s), except in one major application. Read *THE SAVAGE ART* article in the next issue of VTV for more on this.

Ironic--the current worship accorded to this tube by audiophiles is mainly due to the use of its high-mu brother 5691 in the MFA Luminescence pre-amp in the 1980s, followed by a 1992 article about it in *Sound Practices* magazine. There was a small following for "Special Reds" in Japan before this, but no known Japanese equipment specified it.

A highly obscure company, Sheldon Electric Co. of Irvington NJ, introduced a premium 6SN7 for use in TV sets in the mid-1950s. Most TVs before 1955 used a 6SN7 as the vertical oscillator. So, Sheldon introduced the "Hi-Po 6S78" for such use, claiming all kinds of supernatural performance advantages for this tube (along with a few other versions of common TV tubes which they tried to market at the same time). Sheldon claimed in the 6S78's box insert that it would "Make Pictures Bigger, More Stable!" than a standard 6SN7 without offering a shred of proof. It is amazing

how much this "super tube" looks like a period Sylvania 6SN7. And unfortunately, the major manufacturers introduced the 6BL7, 6BX7, 6DN7 and many other variants for vertical oscillator use, causing the 6S78's market to wither.

Some classic hi-fi amplifiers used the 6SN7, though it had nearly disappeared in new designs by 1960. Examples would include: Bell 2145 and 2200, Bogen D010 and H010, Brook 10C and 12A, Craftsmen C-2, 400, 450, C500, C500A, C550, Eico HF-22, HF-35, HF-50, HF-60, HF-87, HF-89, ST-70, Grommes 215BA, Goodell ATB-3 and NSA-20, Harvey Radio HR-15 Williamson Amp, Heathkit W-1, W-2M, W-3M, W-4AM, A-7, A-8A, Interelectronics Coronation 100, Leak TL-12, McGowan WA325, McIntosh 20W-2, Pilot AA-901 and AA-904, Sargeant Rayment SR-570, Scott 210A, 210B, 220A, Stancor Williamson kit, Tech Master TM15A Williamson kit, UTC W-10 and W-20 Williamson kits.

Not to mention a few early FM tuners by Sargent-Rayment and Browning. Please note that most of the above models were top-of-the-line for those companies in the 1946-1956 period. It should be obvious that there was a strong reason to use the 6SN7...possibly that it was the best tube for the best amplifiers. Perhaps the miniature tubes took over for economic reasons, not for reasons of superior quality. And quite often, the manufacturers went over to the 6SN7's miniature cousins, the very similar 6CG7 (RCA, 1949) or the somewhat different 12BH7 (GE, 1950).

Few guitar amps and music devices used 6SN7s. Gibson was fond of using "unusual" types. The Gibson BR-6, BR-6F, BR-9, early GA-40, GA-50T and the Clavioline and GA-46 accordion amp had 6SN7s. So did some Hammond organs and Leslie speakers.

The big exception here is the pre-1956 PA amplifier. Literally scores of models had 6SN7 drivers for the power tubes. Included are models by Altec (1570 family, 1520A, 1530A, and A256), Bell, Bogen, International Projector Corporation, Masco (frequent use of either 6SN7s or 7N7s), Operadio, Newcomb, Rauland, RCA, Stromberg-Carlson, and Thordarson. It is shocking to see how often the 6SN7 or the high-mu 6SL7 was seen in these "low-quality" equipments.

2. Tests

Table 1: distortion of medium-mu single and dual triodes.

*=good used tube. B+ was 250v regulated, frequency 1000 Hz. "Syl tri"=Sylvania tri-angle plate construction, "triode"=tested the triode in a triode-pentode. If the 3rd harmonic was less than 0.015%, it has been left blank.

Arranged in order of increasing second harmonic distortion. Tubes with the same distortion reading are not arranged in any particular order.

Type	Rp used	2nd	3rd
+76 Syl 40s*	37k	.002	
+5687 RCA 50s*	48k	.005	
6CG7 Syl 60s*	25k	.005	
+9002 KenRad 40s	48k	.005	
+76 RCA 40s	37k	.005	
12SX7 RCA 1955	37k	.005	
12SX7 RCA 1955	37k	.005	
+5687WB Syl 1983*	48k	.010	
+396A WE 60s	25k	.010	
6C5G TungSol 30s*	37k	.010	
76 Arcturus 40s	37k	.010	.017
+6GH8A tri Syl 80s	12k	.012	
5814A Syl 70s*	37k	.012	.015
6SN7WGTA Syl 82*	48k	.015	
6SN7WGTA Syl 78*	48k	.015	
+396A WE 60s	25k	.015	
+C-327 Cunn 20s	37k	.015	.017
+56 RCA 30s	37k	.015	
6CG7 JAN Syl 69*	25k	.015	
6SN7WGTA Syl 86*	48k	.020	
6SN7WGTA Syl 83*	48k	.020	
6SN7WGTA Syl 86*	48k	.020	
6SN7WGTA Syl 83*	48k	.020	
6SN7GTB Fuji 60s*	48k	.020	
6SN7GT CBS 54 clr*	48k	.020	
6SN7GTB GE 70s*	48k	.020	
B65 Genalex 1950s*	48k	.020	
6SN7W Syl 1940s*	48k	.020	
5692 RCA red*	48k	.020	

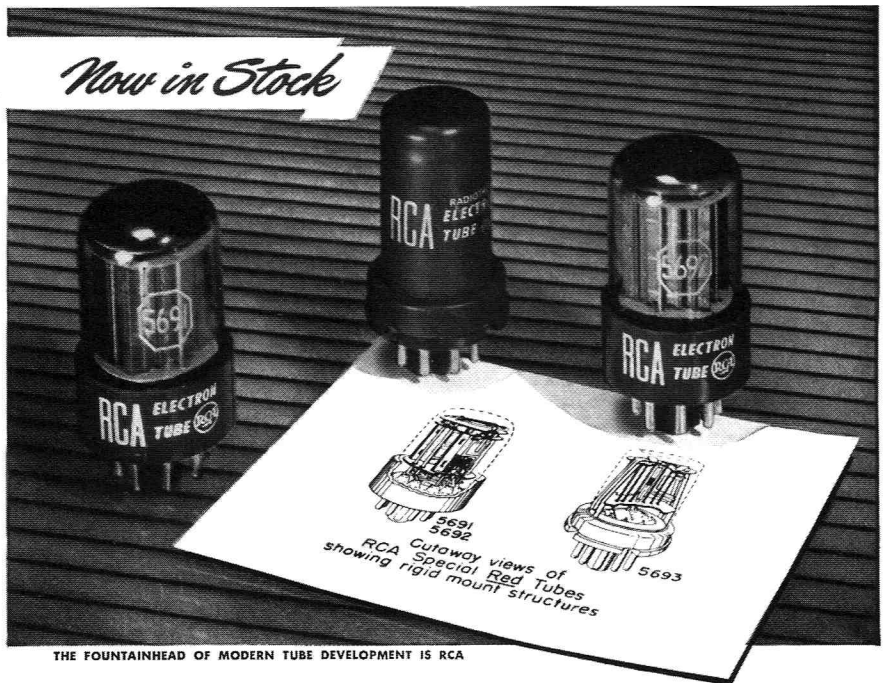

RCA SPECIAL RED TUBES

Minimum life - 10,000 hours!

• Another RCA First . . . these new Special Red Tubes are specifically designed for those industrial and commercial applications using small-type tubes but having rigid requirements for reliability and long tube life.

As contrasted with their receiving-tube counterparts, RCA Special Red Tubes feature vastly improved life, stability, uniformity, and resistance to vibration and impact. Their unique structural design makes them capable of withstanding shocks of 100 g for extended periods. Rigid processing and inspection controls provide these

tubes with a minimum life of 10,000 hours when they are operated within their specified ratings. Extreme care in manufacturing combined with precision designs account for their unusually close electrical tolerances.

RCA Application Engineers will be pleased to co-operate with you in adapting RCA Special Red Tubes to your equipment. Write RCA Commercial Engineering, Section 57FR, Harrison, N. J. For RCA Special Red Tubes to be used as replacements in equipment now in use, see your local RCA TUBE DISTRIBUTOR.

TABLE OF RECEIVING-TYPE COUNTERPARTS

5691	65L7GT (0.6 A. heater)	(0.3 A. heater)
5692	6SN7GT		
5693	65J7		

RCA Special Red Tubes can be used as replacements for their counterparts in equipment where long life, rigid construction, extreme uniformity, and exceptional stability are needed.

SEND FOR FREE BULLETIN—Booklet SRB-1002 provides complete data on RCA Special Red Tubes. For your copy write to RCA, Commercial Engineering, Section 57FR, Harrison, N.J.



TUBE DEPARTMENT
RADIO CORPORATION of AMERICA
 HARRISON, N. J.

6SN7GTA AVERAGE PLATE CHARACTERISTICS EACH SECTION

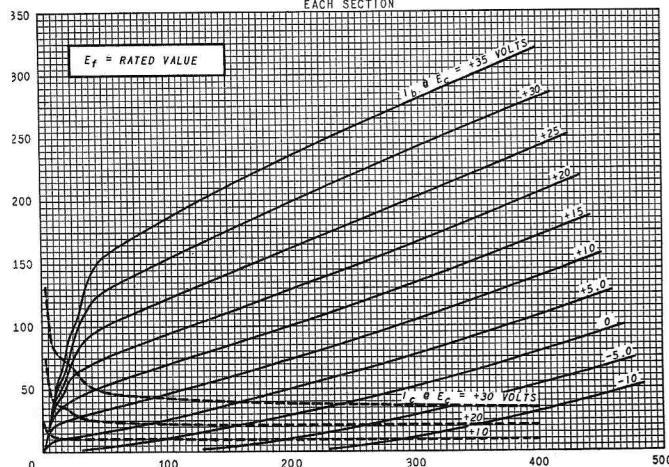

6SN7GTA AVERAGE PLATE CHARACTERISTICS EACH SECTION

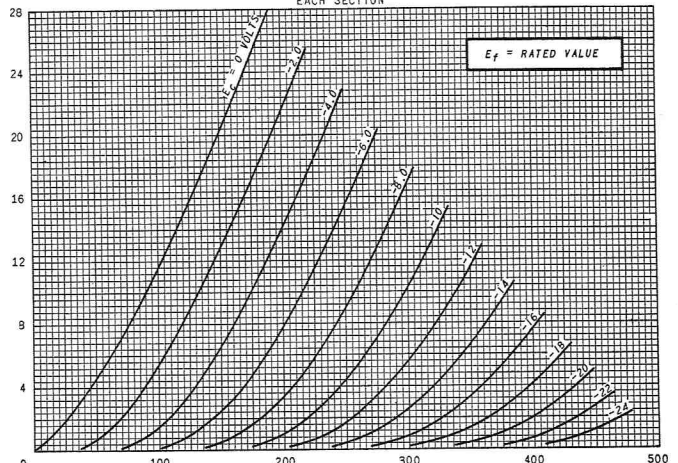

5692 CBS brwn 60s*	48k	.020	
5692 CBS brown 60s*	48k	.020	
6SN7GT GE 1945	48k	.020	
6SN7GT Syl 50s top*	48k	.020	
6SN7GT RCA 40s sd	48k	.020	
6SN7GTB West 1962	48k	.020	
+6J6 RCA 50s*	25k	.020	
6CG7 RCA 1959*	25k	.020	
+UY227 RCA 20s	37k	.020	.015
6SN7GTB Rayth 60s*	48k	.022	
6SN7GTA Tele 50s	48k	.022	
6S78 Sheldon 54?	48k	.022	
CV1988 Brimar 50s*	48k	.022	
CV1988 Brimar 50s	48k	.022	
CV1988 Brimar 50s	48k	.022	
5692 CBS brown 60s*	48k	.022	
+ECC33 Mul 60s blk base	48k	.022	
6SN7WGTA Syl tr 1986*	48k	.025	
6SN7GTA Tele 50s	48k	.025	
6SN7GTA Raytheon 50s*	48k	.025	
6SN7GT KenRad 40s	48k	.025	
5963 RCA 50s	25k	.025	.035
5814A JAN Syl 70s*	37k	.025	.025
+27 Philco/Syl 20s	37k	.025	
6J5GT TungSol 40s	48k	.025	
+ECC33 Mull 50s brn	48k	.025	
+ECC33 Mull 50s brn	48k	.025	
6SN7GTB GE 70s*	48k	.027	
6SN7GTB GE 66*	48k	.027	
6SN7GTB GE 58*	48k	.027	
+6BQ7A GE 70s	25k	.027	
6CG7 RCA 60s*	25k	.030	
6SN7GT Tung 50s	48k	.030	
6SN7GTB RCA 60s	48k	.030	
6J5G GE 30s*	48k	.032	
6SN7/6N8S Russ 90s	48k	.032	
6SN7WGTA Syl 80*	48k	.035	
+5687 RCA 50s*	48k	.035	
CV181 Mullard 52 ST	48k	.035	
CV181 Mullard 52 ST	48k	.035	
+6BQ7A Syl 60s	25k	.035	.015
5814A GE 5-Star 68	37k	.035	.035
5687WB GE 1965*	48k	.037	
+417A WE 60s	12k	.037	
6CG7 RCA clear 60s	25k	.037	
+5687 RCA 50s*	48k	.040	
+6BF7W Jan Syl 1964	37k	.042	.015
6SN7/6N8S Russ 90s	48k	.042	
+7199 triode GE 70s	37k	.045	.030
+5687WB JAN Syl 85*	48k	.055	
12BH7 Syl 60s*	48k	.055	

+= Tubes not related in characteristics to the 6SN7.

The results speak for themselves, but to summarize:

1) Old-stock 6SN7s were remarkably consistent from sample to sample--so much

so that this test was not especially helpful in discerning different 6SN7s from each other.

2) Similar miniature dual triodes were usually less consistent and often had higher distortion than 6SN7s.

3) The forgotten 12SX7GT is VERY interesting.

4) So are the old radio types 27, 56 and 76, as some DIYers have already discovered.

5) As might be expected, the Russian Kaluga 6SN7 is inferior to old-stock units.

One other item: the British versions tended to have a little more voltage gain than the American tubes. Otherwise, their measurements were not especially different. This may account for the "vast" improvement in sound quality claimed for these tubes. Whether they are worth the extra money is up to the consumer.

3. Outro

The 6SN7 has enjoyed almost 60 years of manufacture. Even so, it is used only in a few high-end preamps and power amps today. The world consumption is less than 10,000 pieces per year--not enough to justify low-cost mass production. The only remaining source, Voskhod Kaluga in Russia, recently closed its doors due to the poor economic situation there and the low demand for the tube elsewhere. If audiophiles want to save this classic high-linearity tube for the future, they should get busy and start creating a viable demand for it.

References

1. **70 Years of Radio Tubes and Valves**, John Stokes (Vestal Press, Vestal, NY, third edition, 1992), pp. 55-63.
2. **Tube Lore**, Ludwell Sibley, Flemington NJ, 1997.
3. **Tube Data Manual**, Sylvania Electrical Products Co, 1941.
4. **History of the British Radio Valve to 1940**, Keith R. Thrower (MMA International, Ropley, Hants. UK, 1994).
5. **"Distortion In Audio Phase Inverter And Driver Systems"**, W. B. Bernard, IRE National Convention Record, 1958, Part 7, P. 87.

Many thanks to Phil Taylor in England, Charlie, John Atwood and John Eckland for fact-checking and other information.

www2.netcom.com/~handmade/first.html

Check it out for new stock, sales, small quantity items/closeouts, specials, technical help and a magazine index for projects.

Cerafine 2x47uF/500vdc- \$16.50

Hammond NEW! 300BX power- (for 300B) w/ universal primary- \$136.36 ea. 2@\$115.38 ea. Hammond's Improved SE outputs- 1627/28/29SE- \$105.45 ea., 2/\$91.68 ea.

MagneQuest B7 parallel feed pre-amp output transformers \$65.00-\$99.00 ea. We also stock MagneQuest's matching chokes. MagneQuest parafeed power outputs available.

Kimber 4TC \$5.28/ft, 10ft+ \$5.05/ft Cardas, Hovland, NOS tubes, Tube Sockets & much more! Discounts for smaller users.

Good buys abound in our free

Product Flier No.1

●HANDMADE ELECTRONICS●

P. O. Box 9114

ALLENTOWN, PA 18105-9114

(Birthplace of the transistor)

Voice: 610-432-5732

Since 1992

Visa/MasterCard/Discover

-Export friendly - Friendly service-

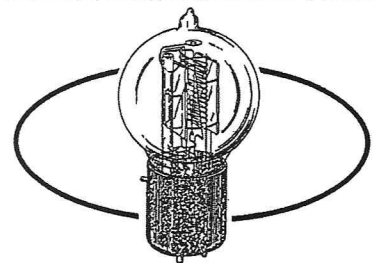

Tubes

Call or Fax Don Singerhouse

(715) 246-3899

SINGERHOUSE
SOUND
PO BOX 321
New Richmond, WI 54017

Listening to 6SN7s

By Charles Kittleson and Eric Barbour

© 1999 All Rights Reserved

There are literally hundreds of 6SN7 types, both domestic and foreign. For this listening test we auditioned several common US types and a few British types that were made available to us for this test by tube dealer Kevin Deal of Upscale Audio.

Our listening panel consisted of: Eric Barbour, Steve Parr, Dave Wolze and myself. It was conducted in the VTV listening studio with the following equipment: VTV Octal Line Stage, Pilot SA232 basic EL84 stereo amp (rebuilt), B&W DM110 speakers, Sony CD player and Monster Cable speaker wire.

As with the previous issue of VTV (#10), we are using a number to rate the tubes in this evaluation. Tubes rated in the 90s are musical and sound excellent, tubes in the 80s are very good, but have minor deficiencies, tubes in the 70s are only acceptable and anything below that is poor. Note that tubes from different batches and different years of manufacture can sound different even though they come from the same manufacturer and have the same structural design. This is due to material and quality issues. We have found that tubes made in the 1980s and 1990s are more primitive sounding than those made in the 1940s through 1960s.

Listening Results

Brimar CV1988 (brown base 1950s). Similar to the B65, but brighter and more detailed sounding. Rating 93

Brimar CV1988 (brown base 1972). An excellent sound stage with a very satisfying and musical presentation. Bass was not as tight as others, but still a top-rated tube. Rating 92

CBS 5692 (brown base 1959). This one had about average detail, but better bass than the RCA 5692s. Gain was a little low, but it was fast sounding with very sweet mids. Rating 92

GE 6SN7GTA (1953). A tube with nice imaging and a romantic, satisfying sound. In addition, it had powerful bass and detailed, accurate mids. Rating 94

GE 6SN7GTB (1960s). This tube was slightly more distorted than the GE 6SN7GTAs. It was less detailed and had

thinner mids. However, the highs were not quite right and seemed somewhat congested. Rating 84

GE 6SN7GTB wafer base (1970s labeled RCA). The worst sounding 6SN7 we listened to in this test. Noisy as hell, sibilant and distorted with harsh highs. To add insult to injury, it was very microphonic. Rating 60.

MOV B65 (aluminum base 1950s). A tube with excellent mids and great detail. Very clean sounding with above-average bass and highs. Rating 90

Mullard CV181 (ST shaped 1952). This is a very well-balanced tube. Great detail and very romantic with zero harshness. It also had very deep bass. An exceptional tube. Rating 97

Mullard ECC33 (1955 thin brown base with very small plates). Slightly more gain than other Mullard types. This one is very detailed and fast with smooth response. Bass is flat and weak, which may appeal to some audiophiles. Rating 86

Mullard ECC33 (brown base 1957). Very prominent, but distorted bass, slightly bright with thin highs. Rating 84

Mullard ECC33 (smoked glass 1960s). A tube with somewhat less gain. Highs are a bit blunted, but midrange was warm. Rating 84

RCA 5692 (red base 1950s). This tube had low gain and somewhat weak mids. Detail was very good, bass was fat but indistinct. Transients were excellent. Rating 92

RCA 6SN7GTB (staggered black plates 1950s). A very romantic sounding bottle with somewhat distorted and fat mids. Highs were weak and recessed. This one might be a choice for listeners with sensitive horn speakers. Rating 85

Philips 6SN7WGTA (tri-plate 1986). This tube sounded slightly bright with good, but not 3D mids. Detail was good and bass response was tight. Last of the US made 6SN7s from the old Sylvania plant in Emporium, Pennsylvania. These are still available from many NOS dealers. Rating 87

Raytheon 6SN7WGT (brown base 1950s). A very musical tube with excellent detail, huge bass, mids were very revealing. This bottle was well-balanced and very fast. Consider this one a top performer. Rating 96

Sovtek 6SN7GT (1990s Russian). A bland and primitive sounding tube. Not very musically involving and nothing special. Used by tube amp OEMs due to its cheap price and ready availability. Rating 70

Sylvania 6SN7W (metal base ring, top getter early 1940s). An early type with a very smooth, well balanced sound. Presentation was clean, but there was less gain than others. Fantastic detail, very tight/clean bass with superb accuracy. Rating 97

Sylvania VT-231 (bottom getter WWII era 6SN7). A well-balanced sound with good imaging and forward mids. Presentation was very smooth and musical, but bass was a little weak. Rating 95

Sylvania 6SN7GT (top getter, black base early tri-plate 1950s). A musical and easy-to-listen to tube with sweet detailed highs. Bass was very good and imaging was excellent. Rating 95

Sylvania 6SN7WGT (brown base with green lettering, top getter early 1950s.) Very clean, dry and "military" sound. Sibilant highs with humped bass. However, it was extremely detailed and fast. Rating 89

Tung-Sol VT-231 (very early, round black plates, smoked bottle 1945). This tube had lower gain, was sibilant, but was very detailed and had excellent highs. Rating 92

Tung-Sol 6SN7GT (round mica side spacers 1940s). A tube with nice detail and musical mids. Bass and imaging were well above average. Rating 90

Conclusion

Without a doubt, the best sounding, most musical tubes in this test were the Sylvania 6SN7W (metal base 1940s) and the Brimar CV181 (ST shape 1950s). These tubes were exceptional performers in our listening setup. Unfortunately, they are very rare and can be expensive. A more readily available alternative would be either the GE 6SN7GTA (1950s) or the early Sylvania 6SN7GT (1950s). Later Sylvania 6SN7WGTs were not as "magical" sounding as their earlier versions. Another great sounding tube is the Raytheon 6SN7WGTA (1950s vintage).

VTV Octal Line Stage Project

By Eric Barbour and Charles Kittleson

© 1999 All Rights Reserved

After a dozen years of listening to "peanut tube" preamps using 12AX7s or 6DJ8s, I asked Eric Barbour to design a simple, good sounding octal-based pre-amp. As many of you know, the reason there are so many "peanut tube" preamps is because these tubes are small and cheap. By the way, so is their sonic performance. Miniature dual triode tubes typically have a small soundstage, tinny sound, are subject to microphonics and can be irritating to listen to. Short of using obsolete 56 or 76 triodes, we decided to use the venerable 6SN7, that can still be found for reasonable prices. The 6SN7 typically has a larger soundstage and is super smooth. As with all tube types, different brands and batches can have noticeably different sonic signatures. The beauty of this line stage is that you can experiment with the literally dozens of 6SN7 types to get exactly the sound you want.

We were not willing to use an ordinary aluminum box for the enclosure, so I contacted SpireAudio. (Note: Unfortunately, at press time, SpireAudio was out of business.) We used a 10x17x2.5 inch aluminum chassis that was powder coated black. All input, output, power, fuse, and switch holes were cut by SpireAudio. The beefy solid aluminum knobs were obtained from Ron Welborne. The result is a professional-looking instrument with lots of room inside for improvements and upgrades in the future.

The circuit design of this project is a classic cathode follower driven by a gain stage. Two 6SN7s are used, one per channel. Overall gain of the line stage is about 12, which should be adequate for most applications. It is possible to use this pre-

amp with some solid-state power amps, but not all.

A 5Y3GT tube rectifier is used in this design, (Figure 1), because tube rectifiers add more "magic" and 3D to the music when compared to typical cheap silicon diodes.

With this transformer, you could also use a 5V4G, but do not use a 5U4, because the filament current is too high. DC heater

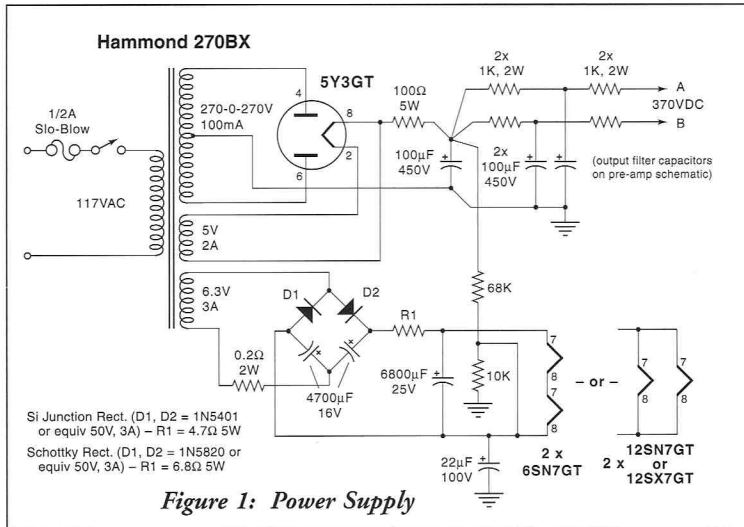
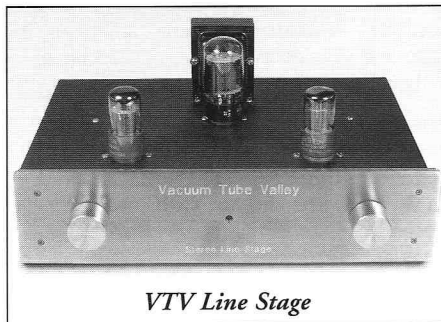

Figure 1: Power Supply

The volume control is a Noble dual 100K type. Performance was improved significantly when we installed a Gold Point dual 100K stepped attenuator. Adding the Gold Point cleaned up the sound and reduced any mistracking of the channels.



VTV Line Stage

power is derived using Schottky diodes. In order to keep hum to a minimum, copious amounts of filter capacitance were needed to keep hum below the 1 millivolt level.

The power transformer is a **Hammond 270BX** (550V C.T., 5V@2A and 6.3V@2A) which allows for a 370V plate voltage on the 6SN7s. Higher voltages make the tube more linear and more "exciting" sounding. The power supply schematic, (Figure 1), also shows how to wire this preamp for 12SN7s or 12SX7s if you desire.

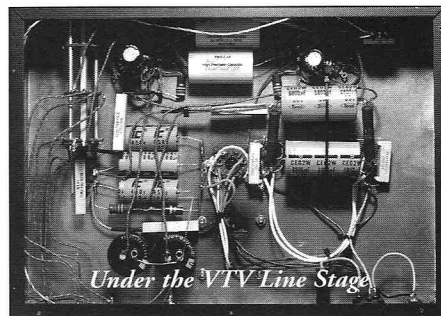

Under the VTV Line Stage

This preamp is a super smooth sounding unit and is very easy to listen to for extended periods without listener fatigue. In fact, we listened to over 30 types of 6SN7s with this unit and loved every minute. Overall, the VTV line stage is a preamp that you can live with for a very long time, perhaps a lifetime.

NOTE: High voltages are used in this project. Use caution and never work on tube equipment when power is applied. VTV assumes no responsibility if you do something careless or stupid while building or using this line stage.

A special thanks to Fred Slaven at SpireAudio in Sacramento for assisting us with the chassis used in this project. Also, thanks to John Atwood, VTV Tech Editor for fine-tuning the circuit.

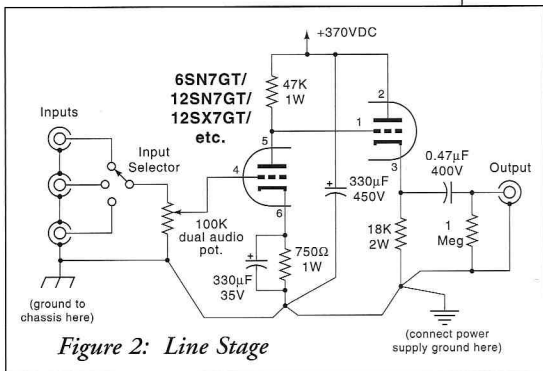

Figure 2: Line Stage

Figure 2 shows one side of the line stage and indicates all component values. Note that the line stage has switching for three inputs. We used an old Dynaco PAS-3 selector switch for this task, but you can use a higher quality gold or silver contact switch. Coupling capacitors used are the Ultra-Tone Silver Foil in oil rated at 0.47uf @650V. These caps are clear, deep and huge sounding.

Inside Richardson Electronics

An Interview

By John Atwood and Charles Kittleson © 1999 All Rights Reserved

The following is an interview with Dan Erickson, Bob Birkeneder and Jerome Czajkowski, Applications Engineers for Richardson Electronics, La Fox, Illinois USA

When and how did Richardson Electronics start operations?

The corporate history actually goes back to 1947 when Richardson first started out as a replacement distributor of electron tubes, so the very basis of the company was the vacuum tube. The first location was Wayne, Illinois, which is not too far from where we are now in La Fox. From Wayne we moved in closer to Chicago, and later we moved into Franklin Park.

What were some of the first products that Richardson produced?

Initially, we distributed vacuum tube products from a number of manufacturers back then. There were suppliers including GE, RCA, Amperex and Eimac. A whole host of tube manufacturers who we were distributing products for—either directly or indirectly. We acquired companies and would also acquire brand names. So as we acquired National, we acquired the National brand, and as we acquired Cetron, we acquired the Cetron brand.

What are the current brands that you are selling now?

We sell Eimac (which became CPI), Amperex, Burle (which was formerly RCA

transmitting tubes); ITT (which recently became Triton); and GE (which became MPD). Plus, we have the older brand names: RCA, Tung Sol, Philips, Raytheon, EEV, Thomson, and Western Electric.

Richardson, I believe, in the past has purchased tube processing equipment from established tube companies that have gotten out of the business. Can you give us a notable example of this?

Richardson purchased the equipment from RCA that came from their small power tube division. That included tube types such as the 811A, the 812A, 810, 845, 211, and a whole host of other ones. We primarily had started building those products for our government contracts. We have also purchased a portion of GE's industrial products, which included Ignitrons. We purchased part of Western Electric—primarily their cold cathode tube division. And along with that, we obtained the equipment for some of their power grid tubes. We acquired Philips and Amperex product lines, which were primarily power tetrodes and triodes, and some receiving tubes. Amperex was still building some receiving tubes when we took it over.

In addition, we acquired portions of the Raytheon Klystron division and portions of the Westinghouse power grid division. Cetron had also been producing photo tubes and some small power grid tubes, such as the 810. Cetron was also building 845's, 300B's, and so forth.

Richardson did not acquire the General Electric receiving tube facility in Kentucky. We did, however, acquire the GE plant in Schenectady, New York, which made industrial tubes. The plant in Kentucky was purchased by its employees. That is when it became MPD, which stands for Microwave Products Division. We became the sole source distributor for the GE receiving tube line, but we did not have anything to do with the acquisition of that plant.

So they still exist as MPD?

They still exist as MPD. They still produce planar triode-type tubes, which are ceramic and metal tubes used in avionics and marine applications. We have also branched off into other things—like

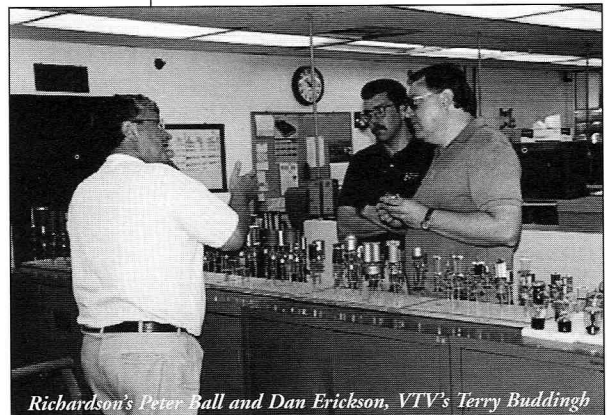

Richardson's Peter Ball and Dan Erickson, VTV's Terry Buddingh

Breathalizers and radar guns and things like that.

When you look at the tube market, how do you decide whether to sell your own tubes or to rely on outside suppliers?

If there is an outside supplier already producing the tube, we will approach them first. We prefer to be a distributor of the product. If there is no existing source anywhere then typically we consider ourselves the manufacturer of last resort. Obviously, when you start something up from scratch, there are a lot of variables that need to be taken into consideration concerning: if the equipment is available; do we have engineers that can do that particular type; are there any drawings that are available from the past; all those kind of things would affect the decision. But basically, once we have determined that, yes, we can build the tube, and no one else is building it, at that point we come up with an estimate for the customer indicating net cost per piece.

Actually, that is one of the reasons we got into producing tubes in the first place back when we bought National. We did

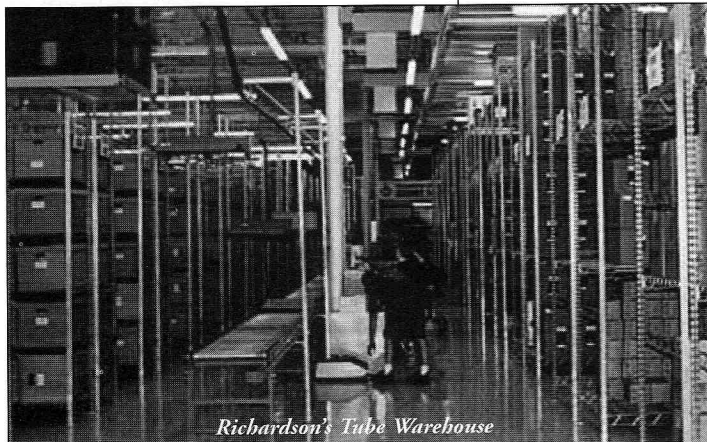

Richardson's Tube Warehouse

that because most manufacturers of the industrial tubes were threatening to exit the business and leave us without product to sell. That is when it was decided that we would go into building tubes to maintain the market. Everybody thought that by this time, the industrial market would decay. This was not the case and it is still not the case today.

What percentage of tube sales are to (1) the military; (2) the hi-fi/audio market; (3) the industrial market; (4) the broadcast market; and (5) other special applications?

If you look at all tube types, which would mean power tubes, receiving tubes, klystrons, you name it, that would fall into the tube area, military sales would be about .5%; the audio and guitar amp market would be 3%; industrial market, 36%; broadcast market, 33%; and "other" markets, 27%. "Other" markets includes medical, avionics and marine. Now if you look just at the receiving tubes, it actually changes quite a bit, because 54% of our sales actually is done in the audio/hi-fi market; industrial picks up 18%; broadcast drops all the way down to 3%; and our "other" markets will pick up 25%. So it really—if you can pinpoint which kind of tube we are talking about, it does make a difference. Depending on any year, 51 percent of our receiving tube sales are domestic and 49 percent are foreign.

How did the recent military base closures affect Richardson and other companies like you?

It was a blessing; and in some cases, it was a nightmare. You had the government selling hundreds of thousands of tubes off and some of the vendors that bought that product are now selling it at below market value. The types that were still being made by China, Russia, Czechoslovakia, those factories are going to see a reduction based on the amount of inventory that was sold off by the government; but that remains to be seen.

Do you see this dumping of surplus tubes continuing in the future or do you think it is going to dry up?

We think it is pretty much done. It seems like the decision was made to start this dump and they did volumes of dumping and now it is down to a trickle. You will find maybe one or two lots of

various types, and now you are getting into the tube types most of your readers wouldn't have any interest in at all—klystrons, old magnetrons, hydrogen thyratrons and things like that. It is the tube oddities that are coming out now.

Is the military still consuming good large quantities of receiving tubes or has that dropped off?

To the best of our knowledge, they have dropped most consumption off altogether, with the exception of maybe one or two pieces of equipment in the military that are still using receiving tubes. They have inventory for them and they are keeping that inventory. But we are only talking about a couple of types that were basically old TV-type tubes.

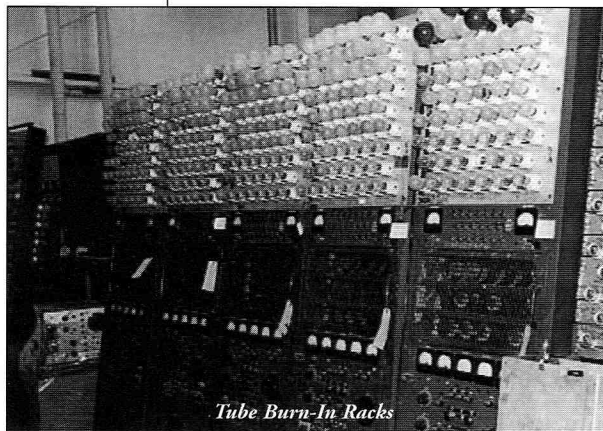

Tube Burn-In Racks

Switching gears here a little bit and getting more into the area that many of our readers are interested in—the new Richardson Audio Products Division. Could you kind of give us an idea of what you are going to be doing with that division—what kind of things we can expect?

APD stands for Audio Product Division and that was really put together with the understanding that this whole market of the audiophile was becoming more and more important. Our focal point would be directly to the consumer. This was something that Richardson could become well-known through. We are a public company on the stock market, so the more references we could possibly get to Richardson was going to help us. In addition, we also had stockpiles of inventory here of the tube types that your readers and our customers would need. If we put our heads together we could determine what audiophiles really need and a lot of it is special one-to-one attention. This is really our first endeavor at the consumer market and because we started out as a tube business for the commercial cus-

tomers, why not branch off into the consumer market?

We set up an APD customer service operations here in La Fox. APD employees were picked for their ability for excellent customer service, because we knew they were going to get a lot of questions, probably more so than they would get on the commercial side.

We also needed applications engineering that could answer more technical questions. We now have four different engineering staff that are involved in APD.

One of the things that we have done is the re-introduction of the Amperex Bugle Boy. With the acquisition of Amperex, we acquired some of the equipment that was used in the original manufacturing of their receiving tubes. We now age audio types under full load for 24 hours on the original Amperex aging equipment. Once they are aged, we perform the various tests on them including a full harmonic distortion test. The Bugle Boy is a premium-grade tube, and a product that will be stable, for one thing, and will hopefully be pleasant to the ear when you plug it into the equipment. With each tube, there is a test certificate indicating individual performance measurements.

Most of the original Bugle Boys were made in Holland or other European countries. What is the country of origin for your new Bugle Boys?

We use Philips tubes, GE tubes and other high-quality brands that we have in stock.

One of the main things that VTV readers ask us about is what the sound of the tube is like. And even though it's a little hard to measure—some particular brands have had certain types of sound. If a customer buys a new Bugle Boy from Richardson, will we be assured to get the same sound quality as the original Bugle Boy?

That is a good question. We have a large supply of tubes in inventory that will remain constant for some years to

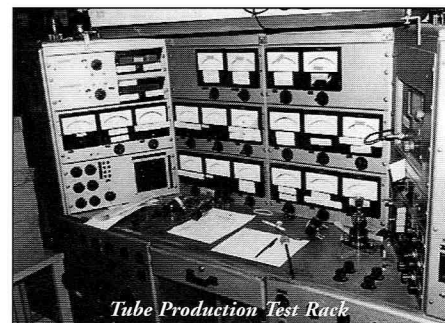

Tube Production Test Rack

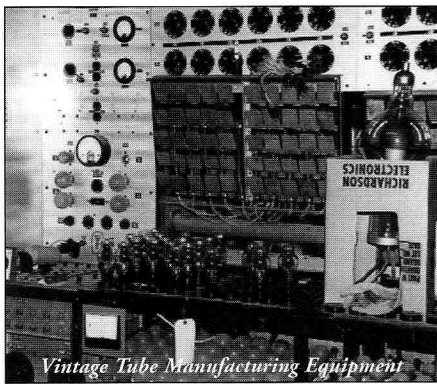

Vintage Tube Manufacturing Equipment

come. We measure the tubes with Hewlett Packard spectrum analyzers that are very accurate. Once we've established a specification, we are not going to change it for a different manufacturer's tube. If their tube doesn't make it, it doesn't make it, period. We're not going to deviate from the specification just because we might have to change the supplier some time in the future.

Which tubes are you going to be introducing in the Bugle Boy line?

Initially we introduced the 6DJ8, 6922, 12AX7, 12AU7 and 12AT7 Bugle Boy types. Later, we will bring in the EL34 and 6550A types as Bugle Boys. In addition, the new packaging looks better than the original Amperex packaging. Plus, we are using the original Bugle Boy logo on each tube.

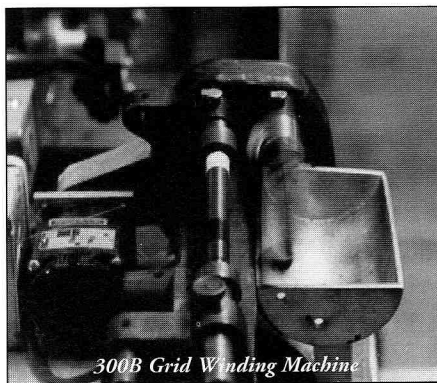

300B Grid Winding Machine

What types of audio tube types will Richardson actually be manufacturing in-house, if any, next year?

The only ones that we are currently making is the 300B and the 845. We built the KT88 for McIntosh to use in their re-issue MC275 power amplifier. But we found that to continue production, you need a large audience to be purchasing these things. And, quite honestly, when you start getting up over one hundred dollars per tube, for a KT88, we find that people are very reluctant to spend that kind of money. So, that's one of the rea-

sons we stopped producing the KT88. Unless we had an OEM that came to us and said, "Look, I want this and I want to buy x number tubes." I mean, it goes back to what we said earlier to determine whether we are going to build a tube or not. We really can't keep production going on something that is very difficult to sell because of the price. All of our tubes are put together by hand. We don't have any automated equipment producing tubes.

Do you still have a stock of the Richardson KT88?

We have sold the entire stock we had.

Do you plan to reintroduce the 7591A?

No, but we would consider distribution of the 7591A if another vendor produced a quality product.

Do you have plans to introduce any new tubes or new designs, the way Svetlana did with their SV811 series?

If we had somebody who came in and said, "I'll pay for developmental costs, and I'll guarantee you an x-thousand production run of these tubes," we would consider doing that. But other than that, no. We don't have any intentions on doing that.

Could you explain your tube matching and quality control process for audio tubes?

Somebody may call us and say they need a pair of 12AX7As, for example, and they are not looking to buy the Bugle Boy series. In that case, we would take tubes without any aging, test them, and match them for plate current, and that would be a matched pair. We do that with power grid tubes in the broadcast industry, as well. We do an incoming inspection on all the product that we buy. We take a percentage sample from each shipment, and run it through its paces to make sure that it makes specification, looks good and that there are no physical defects to it.

This may be a nitpicking point, but does that mean that you only do sample testing on the lots, or does every tube go through at least a minimum test?

We follow guidelines much like the military, as far as their inspection process on product.

How do you plan to cultivate the growing public interest in tubes, audio amps, pro-audio, etc?

Obviously, one of the main ways is to advertise more. We are advertising in publications such as your own and others. We will be at different trade shows. As you know, I think probably more than anybody, word of mouth in this particular market is so strong, that we are counting on that, as well. Once we get some favorable feelings out there from the customers about how well we can serve their needs, that should help to play a part in how successful APD becomes.

Beside vacuum tubes, do you plan on getting into other audio or hi-fi related products?

In the long term, yes. We have discussed several different products including tube dampeners, premium capacitors, transformers, etc. But what products those are and who the manufacturers of those products will be has not been determined yet.

Where do you see the future of vacuum tubes in audio going? Do you see it going as an indefinite thing or is it a just a passing fad?

I think tubes are reaching a far broader market, and they are now reaching the 20-something males. Often these are guitar players already using tube guitar amps. Some of these people can afford to get into other types of tube gear. Also, there are new audio publications coming out specifically dealing with vacuum tubes. In addition, the established audio publications are reviewing more and more tube equipment, every month. So all indications are showing that the market is growing, and has been doing so since, I would say, the late 80's. With more manufacturers coming out with lower-priced tube gear, and with speaker manufacturers making speakers that really work quite well with tube amplifiers, I think the market is really going to be on the upside for quite some time.

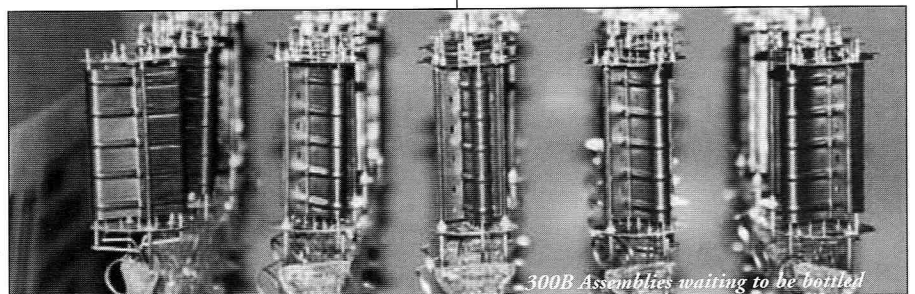

300B Assemblies waiting to be bottled

Mid-Priced Vintage Hi-Fi Equipment

Acrosound through Leak

By Charles Kittleson © 1999 All Rights Reserved

In VTV #9, I discussed budget priced tube hi-fi components under \$350. This time we will examine mid-priced components in the **\$351 to \$1,000** (1999) range. These components are a bit more difficult to locate than the budget units due to their lower production figures and collectability. Cosmetic and electrical condition is a major consideration if you plan to collect them for investment purposes. For some reason, mint vintage hi-fi does not have a huge price differential from equipment that is in average condition. This is not true with other collectibles like guitars; for example, with an average condition 1961 Fender Stratocaster selling for \$2,000-3,000 and a mint one selling for \$20,000+.

I have been a serious collector of vintage hi-fi for over 10 years, and I know that for every 50 average condition units of a particular type, only one or two will be found in mint condition. In the future, vintage hi-fi in primo condition will have much higher collector value because gear in that condition is very scarce. Many of the items listed for in this article are already hard to find, especially mono power amplifiers in pairs. If you find one, it may take you a while to find its mate and you may have to pay more than you did for the first one.

When buying vintage audio gear strictly for investment and not for listening purposes, it is generally best to not replace older capacitors, rectifiers, resistors, etc. with new parts. True collectors will pay the most for totally stock, original pieces.



Acrosound UL-II (1958)

If you plan to use any of the equipment listed in this article, thorough repair and restoration will be required. Tube amplifiers have simple circuits and are normally easy to restore, but tuners and preamps are more challenging. Best performance results will be achieved by locating an experienced and reliable tube hi-fi technician locally or through the mail to perform vintage tuner and receiver restoration. Or, if you have the electrical and mechanical ability, conduct the restoration yourself. It is a must to obtain a schematic and/or service manual beforehand.

Restoration of tube gear includes: cleaning and dusting of the unit, cleaning and lubricating of switches and connectors, testing and possible replacement of tubes, replacement of old paper and wax capacitors (especially in high-voltage and coupling circuits) with good-sounding film types, replacement of selenium bias, B+ and filament rectifiers with silicon or FRED diodes, testing and replacement of electrolytic bias, filament, B+, etc. capacitors, checking all resistors for any drift, replacing resistors in the phase inverter with new close tolerance units, checking all important circuit voltages, and setting DC bias and balance. Tuners and receivers may require tuner alignments and possible replacement of IF cans, coils and other RF parts.

When the restoration is complete, you will have an attractive, good-sounding and unique audio artifact to display and listen to. Remember that amplifier power ratings in excess of 50-60 watts are rare in the vintage hi-fi world. If your speakers are satisfied with 30 to 60 watts, you will find some extremely good sounding amplifiers in this article. Don't forget that 60 watts of tube power will sound a lot louder than 60 watts of solid-state power. Several of the items listed here are more musical and pleasant to listen to than newly manufactured gear costing many multiples of the cost paid for vintage gear. An advantage for purchasing and restoring vintage gear is that it typically appreciates with age.

The following list includes desirable mid-priced vintage audio items. *By no means is this list exhaustive*, but it includes equipment that is sonically satisfying, cosmetically pleasing and has investment potential. While this equipment is somewhat scarce, it can still be located using the Internet, audio buy/sell publications and referrals.

Acrosound UL-II Amp

The 60 watt Acrosound UL-II Ultralinear amp came out in 1957 as either a kit (\$79.95) or assembled (\$109.95). Herb Keroes, designer of the Ultra-Linear Acrosound transformers, decided to get into the audio kit game with the UL-II and subsequent amplifier and preamplifier products. The UL-II was a very attractive audio artifact featuring huge potted transformers on either side of the two-tone metallic brown chassis that included a tube cage in the center. The UL-II featured the famous TO-600 output transformer and a potted power transformer. Most of the electronics and all of the tubes were mounted on a circuit board. This board was a weak point of these amps, because it got brittle from heat and age, causing the traces to lift from the board. Be sure to carefully inspect the circuit board for damage before purchasing this amp. Another weak point of the UL-II was the power transformer. For some reason, they chose to include the filter choke with the power transformer in the potted enclosure. The transformer can fail from age, extended use or shorted filter capacitors. Tube complement includes: 12AX7, 12AU7, two EL34s and a 5AR4. The amp can be re-biased to accept 6550s if the user desires. The sound quality of the ULII is exceptional. Measured frequency response was 5 to 100,000 Hz + or - 1 dB. The music presentation is smooth and rich with live-sounding midrange. The sound is balanced throughout the entire frequency range. Some vintage amps in this power range can have boomy or loose bass, but the Acro is pretty tight. There is a variable control on the amp that adjusts the damping factor from .5 to 10. According to many vintage audio enthusiasts, this is one of the best sounding 50 watt mono amps of the era. Finding ULII in pairs and in good condition can be difficult. The cheap circuit board, as well as the power transformer (which is prone to failure), can be challenging.

Dynaco Mark III

Probably the most common vintage mono tube hi-fi amp ever produced in the United States, the Ultralinear Mark III is still easy to locate. The Mark III was

**Dynaco Mark III**

introduced in 1957 and initially sold as a kit for \$69.95! Producing 60 watts of power and featuring the excellent A431 Dynaco Ultralinear output transformer, this amp was an immediate sensation. It was the successor to the Dynaco Mark II, an EL34 push-pull amplifier that was Dynaco's first product, introduced in 1955. The Mark II only had output taps for 8 and 16 ohm speakers, while the Mark III added a 4 ohm tap. The chassis was nickel-plated and featured a gray-brown cage that covered the entire amp. Apparently, Mark IIIs were produced until the late 1970s. This was the first popular tube amp in America to use the Genalex KT88. Modern 6550s can also be used with no modifications. The front-end circuit was on a single-sided printed circuit board and used a triode-pentode 6AN8. The rectifier was the slow-warmup 5AR4.

There were dozens of mods and upgrades developed for the Mark III. Many of these were published in *Audio Amateur Magazine* and other related publications. Several companies currently offer upgrade driver stage and power supply modification kits as well. No specific recommendations can be given for any of these mods or upgrades, so it will be best to ask around.

In stock form, the Mark III is a powerful sounding amp, but with super-efficient speaker systems, the bass may seem a bit flabby and the mids a little hard sounding. Replacing the coupling and electrolytic capacitors can improve the sound, though. This amp was initially designed to be used with the low efficiency new acoustic suspension speakers such as those produced by AR and KLH in the late 1950s. Therefore, I would not recommend using the stock Mark III with super-efficient and horn-type speakers.

EICO HF87

The HF 87 was available in kit (\$74.95) or assembled (\$114.95) form from 1959 through 1965 or so. This was a beefy unit with an excellent front-end design using a single 12AX7 and two 6SN7GTs. High-

quality components and circuit design required less feedback and produced less distortion. Each 35 watt channel of the amp used a direct-coupled voltage amplifier stage driving the cathode-coupled phase inverter coupled to the Ultralinear, self-biased output stage. The power supply is a voltage doubler using silicon diodes, a current-limiting surgistor and ample filter capacitance. A plus is that the entire amp is point-to-point wired, allowing for easy upgrading and modifications. Good upgrades include replacing coupling and bypass caps, replacing power supply diodes with low-noise FREDs and replacing resistors in the phase inverter and first audio stage plate resistors with 1% precision units.

This amp is solid sounding and an alternative to the Dynaco Stereo 70. In fact, I would rather listen to an HF 87 than any stock Stereo 70. Sound is clear, and powerful, but still has detail and transmits the musical energy. Published frequency response was measured at 5 to 100,000 Hz + or - .5 dB. Hum level was 90 dB below full output. Many modern tube amplifiers would not be able to meet these specs. With 35 watts RMS per channel, the HF87 will effectively drive most home audio speakers with ease. Note that the matching preamps for EICO tube stereo amps were their **HF85** and **ST84** models.

EICO HF89

Also available in kit or assembled versions, this 50-55 watt per channel stereo amp is one to look for. It is another "sleeper" amp with huge output transformers (that according to John Atwood, VTV Technical Editor, have outstanding low frequency response). Bruce Tilden, a local transformer expert, claims that the HF89 output transformers go down to 4 Hz! Apparently, they were sourced to a vendor other than Stancor or Chicago, whom EICO used for most of their iron.

The circuit is similar to the HF87 above, but the output tubes operate in fixed-bias mode and the B+ voltage is slightly higher. This amp is truly one of the best vintage tube stereo units, with a balanced sound throughout the music spectrum. Bass response is nothing short of spectacular, with mids and highs that are sweet and detailed. Upgrades and mods are similar to the HF87 listed above. The HF89 was made in fewer numbers than the HF87 and will be somewhat more difficult to locate.

**EICO HF89**

EICO HF 50 and HF60

Both the classic EICO mono HF50 and HF60 amps use the Mullard-type front-end circuit. A single low-noise EF86 was direct-coupled to a 6SN7GT cathode-coupled phase inverter driving push-pull EL34s in Ultralinear mode operating in fixed-bias. The rectifier was the slow-warmup, indirectly heated cathode 5AR4/GZ34. The circuit was designed with 21dB of inverse feedback and a damping factor of 12 or more.

These amps were similar in many ways with the exception of the output trans-

**EICO HF60**

former. A super high-quality potted Chicago transformer was used on the HF50. This transformer has great high-frequency response + or - .5 dB from 6 Hz to 60 KHz.

On the HF60, an Acrosound TO-330 output transformer, was standard for a slightly higher cost. The frequency response of this transformer was an outstanding + or - .5 dB from 5 to 100,000 Hz. HF50s and HF60s are getting hard to find, but are both great vintage power amps. The HF50 has a tilt towards the high frequency range and sounds more extended than the HF60 which has a great bass response, but in stock form is a little darker sounding than the HF50. Both amps can be easily modified, by connecting the EF86 in triode mode,

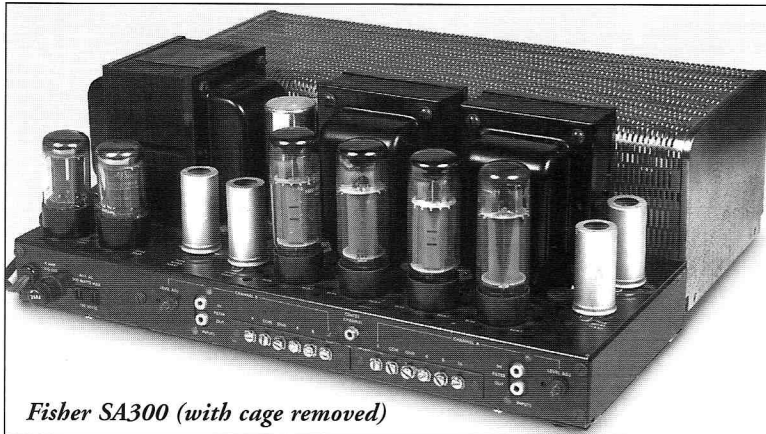

Fisher SA300 (with cage removed)

connecting the EL34s in triode, beefing up the power supply and replacing the selenium rectifier with a fast recovery diode.

Fisher SA300

This was Fisher's first mid-power stereo amplifier. It was introduced in 1960 and was made for about three years. It was called a "laboratory amplifier" because it featured full adjustment of bias, DC and AC balance and AC hum. The amp used push-pull EL34 tubes with an all triode front-end (12AX7 and 12AU7) and dual GZ34 rectifiers. Rated power was 30 watts per channel RMS, but it actually put out closer to 37-38 watts per channel. Its power supply was very beefy and featured a huge power transformer and ample filter capacitance. A later version, the SA300B, had slightly different circuitry, but the same tube compliment.

Modifications and upgrades include



Fisher 400CXII

replacing all coupling and bypass capacitors, replacing low-voltage electrolytics and bias caps, checking and replacing phase inverter plate and grid resistors with 1% metal film units. It is best to obtain a factory schematic and service manual for the correct bias, AC and DC balance procedures.

Compared to many push-pull EL34 amps, the SA300 is very modern

sounding with a good deal of high-frequency detail and quickness. Bass response is powerful, mids and highs are detailed, but not to the point of irritation. The sound is close to a Marantz 8B amplifier at a fraction of the price. Another great-sounding amplifier from



Fisher FM200B

the same era is the push-pull EL84 Fisher SA100 basic amplifier. The SA100 is similar in styling, but produces less power.

Fisher 400CXII

A perfect match for the SA300, the 400CXII is a full-featured tube stereo preamp. Preceded by the 400 preamp, the 400CX has more tubes and more features. There were at least three versions of the 400CX with the last version called the 400CXII. Do not confuse this with the earlier 400 preamp that was introduced in 1960. The earliest version has oval shaped

selector buttons and a lacquered brass faceplate. Later versions had a brushed aluminum faceplate with round selector buttons.

A weakness of the 400CX is its complexity with a plethora of switches and controls. Regularly cleaning the switches, connectors and tube sockets can make a dramatic difference in the sound of this

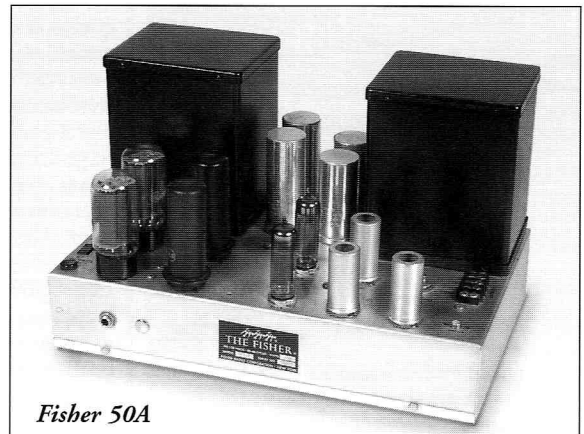

Fisher 50A

preamplifier. Using high-quality NOS tubes is also essential when using a 400CX in your system. When these preamps are upgraded, the sound is lush and rich. Note that the earlier Fisher 400 stereo preamp is also a good performer, but can sound veiled unless completely rebuilt

with new components, especially signal path capacitors and resistors.

Fisher FM200B

One step below the famous FM 1000, the FM 200B is an extremely sensitive and selective FM stereo tuner. Fisher produced more good sounding tube tuners than any manufacturer in the world during the early to mid-1960s.

When Fisher and Scott tuners are compared with each other, most listeners prefer the Fisher. Fisher FM has a rich, sweet detail that is fuller sounding than most Scott tuners, which tend to have a thinner sound.

The 200B uses a dual Nuvistor front-end and has five IF stages. Dual 12AT7s are used for the cathode-follower output. Most of the other tubes are common tuner types that are easy to obtain. The front-end tubes in tuners are run hard and should be frequently checked. The other tuner tubes have an average lifetime. As with most tuners, proper alignment is key to the best performance.

Fisher R-200

The R-200 is basically an FM100B with a very sensitive AM section. Although the R-200 does not have a Nuvistor front-end, it is still a very sensitive and good sounding unit. Some experts consider the R-200 a better-sounding tuner than the FM200B. If you listen to AM radio talk shows or sports



Citation II



Citation V

coverage, the R-200 may be your ideal tuner.

Fisher FM1000 Tuner

The FM1000 and its rack mounted version, the FMR-1, were the finest FM stereo tube tuners ever produced by Fisher. This legendary performer had six IF stages, two meters, extensive controls and a cathode-follower output. The FM1000 is super sensitive and is very life-like sounding, especially if carefully serviced and aligned. Fisher also produced a rack version called the FM1000R, used by FM radio stations for monitoring and re-broadcasting.

Fisher X1000 Integrated amp

This beautiful device was Fisher's largest tube integrated amp. Using push-pull EL34s, it produced 55 watts RMS per channel! The X1000 was the most powerful tube stereo integrated amp during the 1960s. Output transformers were huge and the amp weighed in at almost 50 pounds. The X1000 was full-featured and featured a center channel volume control as well as a control for the Fisher Space Expander reverb system. Not only is the X1000 large, it is probably the best sounding high-powered tube integrated amp ever produced. There are two versions of the X1000. The first version had brown bakelite knobs with no brass cap. The second version of the X1000 had the new brass medallion knobs and a head-phone jack was added.

Fisher Mono Power Amplifiers

During the 1950s, Fisher produced several great-sounding tube mono-block amplifiers. All of these amps used ultra-high quality potted output and power transformers for noise reduction and cosmetic reasons. The first of their component amplifiers was the 50A (pictured) and the later 50AZ that featured variable speaker damping. The 50A was a 40 watt triode-connected 6L6 amplifier with dual

rectifiers and a driver choke design. High-quality potted transformers were produced by Freed Transformer Corporation. 50A amplifiers are very sweet and mellow sounding and work well with horn loudspeakers. Later Fisher monoblocks not pictured include: the **55AZ** with push-pull 6550s (and later EL34s), the **70AZ** with push-pull 5881s, the **80AZ** with push-pull EL37s, while the Fisher **100** was basically an 80AZ with different cosmetics and the Fisher **200** used push-pull EL34s (note: the Fisher **90AZ** and **125AX** will be featured in later articles on Fisher). All of these amps are beautifully made, sonically satisfying and are worth picking up. Generally, they need restoration work including new capacitors, diodes, tubes, etc. Occasionally, you will find an amp that has a blown driver choke and this situation can be challenging.

Harman-Kardon Citation Series (tube type)

The Harman-Kardon Citation I thru V Series tube audio line were introduced in the late 1950s and sold through the mid-1960s. They were offered either as kits or fully assembled and tested. The Citation Series were attractive and had the massive styling of the early 1960s including turned aluminum knobs, champagne faceplates and thick cadmium-plated steel chassis.

The **Citation I** was a full-featured pre-amp with an unbelievable array of controls and features. Some enthusiasts feel that this was one of the best vintage tube preamps ever made. Others think it is overly complicated and has too many stages. The circuit topology is anode-follower based, which can improve low frequency response. The preamp has 18 stages of gain and utilizes nine dual-triode tubes. The design used passive equalization in the phono stage that required an additional gain stage.

A match to the Citation I, the **Citation II** was a beefy, high-performance power amplifier that was an exceptional performer. This 120 watt amplifier used push-pull KT88s in Ultralinear mode. Massive, potted output transformers made for HK by Magnetic Windings Corporation of Easton, Pennsylvania, were stable to frequency extremes beyond 200kHz. A high-capacity power supply using silicon diodes and a voltage doubler was used with the potted power transformer. The Citation II was a controversial design in that it used three feedback loops to obtain super low distortion.

This amp features a voltage doubler 450V power supply that is very similar in design to the Citation V and Lafayette 550 power amplifiers. Some enthusiasts did not like the sound of the all pentode front-end and consequently changed the driver tubes to triodes. In addition, many Citation IIs were scrapped for the super high-quality output transformers by custom tube amp builders during the 1980s.

The high power output and super-wide frequency response enabled the Citation II to drive most loudspeakers. (For more detailed information on the Citation I and II, see VTV issue #4.) There a few critics of the Citation II amp who claimed it "gave them a headache after extended listening."

Citation produced a high-quality FM mono tuner, the **Citation III** and later, the Citation IIIIX (stereo multiplex version). HK claimed in their literature that the III was the world's most sensitive tuner (0.65 microvolts for 20 dB of quieting). The front-end utilized a Nuvistor, there were three IF stages followed by a wide band Foster-Seely discriminator, two tuning meters, two gated-beam limiters to ensure exceptionally high capture ratio and lower distortion. The Citation III had a special design wide band audio circuit for extended frequency response and "unmeasureable" phase shift. Many tuner



Heathkit SP-2

enthusiasts claim that a properly restored and aligned Citation IIIIX is their favorite tuner in terms of sensitivity, separation and audio performance. However, the Citation IIIIX multiplex unit is questionable and a nightmare to work on. An external multiplex adapter is recommended.

A little later in the Citation series run, HK introduced the **Citation IV** stereophonic control center. The IV was a compact and less complicated preamp compared to its older brother, the Citation I. The preamp was full-featured, but only used six dual triode tubes with an anode follower output. It had separate tone controls that were able to be switched out of circuit as well as a variable blend control for the center channel output. Note that when the tone control was switched out, absolute phase was changed. HK used DC on all heaters as well as low noise metal film resistors in critical places to reduce thermal agitation and hum. Many vintage hi-fi enthusiasts claim that the Citation IV is a better sounding, more musical preamp than the Citation I.

The **Citation IV** has a tiny outboard power transformer mounted on the back of the unit that almost looks like an afterthought. Apparently, relatively poor quality parts were used. Use caution when upgrading the Citation IV. Try not to use too many metal film resistors. Also be sure to replace the electrolytic output caps with modern film types.

Citation V was the last of the Citation tube hi-fi line and was an excellent performer. This 80 watt stereo amplifier had a simpler circuit than the Citation II and featured the newly introduced GE 7581 type which was an updated 6L6GC. The circuit featured only one feedback loop with a single 12BY7 and a single 6CG7 in the front-end driving the output tubes in straight pentode mode through super high quality output transformers designed with resonant frequencies above 200kHz.

It has been rumored that the Citation V was not designed by Stu Hegeman. The output transformers are not potted and

appear to have been manufactured by another vendor. They are thought to have a slightly hazy sound and lack of transparency when compared to the Citation II

transformers. The Citation V is one of the easiest amps to modify to full triode input (replacing the pentode (12BY7) with a triode (a 12AX7 does wonders). The triode input converted Citation Vs are real contenders. And since the power supply voltages, etc. are essentially identical, this circuit works well with the Citation II. With this modification, the amp sounds extremely transparent.

Heathkit SP-2

Heathkit's deluxe stereo preamp was the SP-2. It was a modular unit where you could start out with one channel and the power supply, then upgrade to stereo, by buying the other channel. The SP-2 had typical styling of the late 1950s with a black faceplate, brass insert knurled knobs and a black and gold-swirl case. Most components were mounted on a circuit board and each channel featured two dual triodes and an EF86 pentode. A unique, but frequently lost accessory was the remote stereo balance control on a long cable. The matching Heathkit amp is the AA-40

Knight KB-85 Amplifier

During the late 1950s and early 1960s, Allied radio produced some great sounding tube hi-fi gear for bargain prices. One of these amplifiers was the KB-85, a 60 watt tube stereo amplifier on a chrome chassis. The amp featured ultra-wide response potted Chicago transformers and push-pull Mullard EL-37 output tubes. The front-end was a Mullard design using an EF86 and a 12AX7 for each side. There were also dual 5AR4 rectifiers and a massive power transformer.

Knight KP-50 Tube Preamp

This was a very unique stereo preamp offered in kit and assembled versions. It used 12AY7s in the phono stage and 12AU7s in the gain and output stages. A modular circuit board construction makes this unit a bit of a bear to work on. This unit essentially fleshed out the preamp

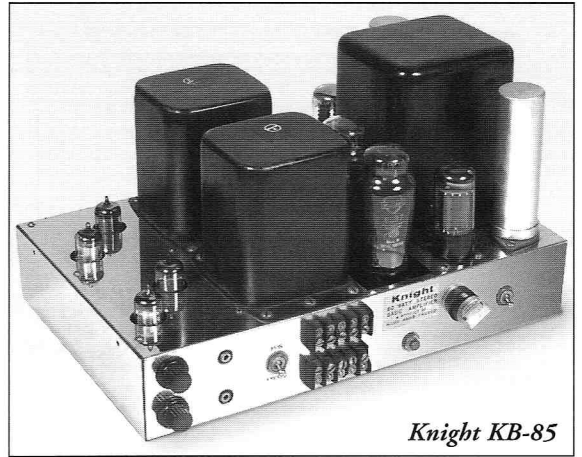

Knight KB-85

design that was used in at least two of Knight's integrated amplifier designs.

The KP-50 unit has two phono inputs with some rather unique switching. One phono is a conventional RIAA stereo input and the other is a mono only and has selected jacks for specific old phono cartridges (GE, Pickering, etc.). When the selector is in this position it also activated various old record equalization curves.

Lafayette KT600A

According to many enthusiasts, the KT600A preamp is the best sounding vintage tube stereo preamp. Designed by Ed Duda, former Lafayette Electronics designer, and Stuart Hegeman of Harman-Kardon Citation fame, the KT600A was available in either kit or assembled form. The circuit used eight 12AX7s and a selenium rectifier stack. The preamp uses an anode follower topology for the line-out to the amplifier. This may be one of the reasons the KT600A sounds so good. Apparently, Stu Hegeman did not like the sound of cathode followers. A similar concept can be seen in the Harman-Kardon Citation I and V preamps.

Most of the components in the KT600 are mounted on a beefy, thick circuit board. Power supply and filtering capacitance is very ample. In some KT600s, the power transformer can exhibit a slight buzz. Some enthusiasts fixed this problem by building a separate power supply. Like most preamps of this era, plastic-cased paper capacitors are used. In most cases, these capacitors should be replaced for the most sonic detail. In addition, the selenium rectifiers for B+ and filament voltage must be replaced because they develop a high series resistance with age. This condition lowers the voltage and produces excessive heat in the rectifier.

Lafayette KT550 Amplifier

This design was completed by Ed Duda with some involvement by Stu Hegeman. In a weird way, the design philosophy combines the multiple feedback wide band design of the Citation II with the output stage of the Citation V. The 550 was designed prior to Hegeman going to work for Harman-Kardon. According to a recent conversation with Ed Duda, Hegeman left in the middle of the project and the design was completed by Duda. Some feel that the 550 was a prototype for the later Citation II design.

It is a standard pentode design using Acrosound transformers and was originally intended to use 6550s, but for cost reasons, the design was changed to accept the newer RCA 7027As. The 550 uses 6CL6 pentodes in the input stage and a 6BR8A in what is probably the strangest phase inverter on the planet. As mentioned earlier, the power supply is essentially identical to the Citation II.

Sonically, some consider the KT550 amplifier to be much warmer and more dimensional than the Citation II, albeit with a slight amount of grain. This unit also lends itself to the triode input/driver modification mentioned above (see Citation V). The output stage can be made to accept almost any output tube from 6L6/KT66, EL34 to 6550/KT88 tubes.



Leak ST20

Leak ST20

Throughout the 1950s until the mid-1960s, Leak produced some of the most attractive, finest built and excellent sounding equipment available. The ultra-linear ST20 (1958-67) combines two Leak TL12+ amps on one chassis. This 10 watt per channel amp uses push-pull EL84s, three 12AX7s and a 5AR4 rectifier. Most of the circuit components are mounted on military-style turret boards and the wiring quality is beautiful. Not to mention the deep metallic gold lacquer finish on the chassis and transformers. Both the output and power transformers

have switchable taps for varying line voltages and speaker impedances.

Sound quality is balanced, rich and musical. The ST20 represents the epitome of British EL84 sound. These amps are easy to upgrade because 90% of the parts are mounted on the sub-chassis turret board. Sonics can be improved by re-capping and checking/replacing key resistors. It is best not to modify these highly collectable units.



Leak ST60

Leak ST50 and ST60

The big brother of the ST20 is the ultra-linear ST50 (1958-63) (\$189.00) that uses EL34s. Power output is about 25 watts per channel. Leak specifies that you can use either EL34s, KT66s or 5881s in this amp. Each of these tubes will give a different sonic signature. Other tubes are similar to the ST20 mentioned above. Cosmetically, this attractive amp has the same gold lacquer finish as other Leak products. With the ST60 during 1962 through the mid-1960s, Leak upgraded the power of the ST50 to 30 watts per channel by increasing the B+ voltage. They also abandoned the metallic gold finish with the **ST60** (also ultra-linear) (1964-67) and finished it in dark maroon.

Construction quality is the same as the ST20 and very easy to upgrade. The matching preamp for the Leak stereo amps is the Leak Point One Preamp. A very "60s" looking piece with an engraved and back-color filled plexiglass faceplate this is the perfect match to the other Leak products. The Point One used four EF86 tubes and was powered by plugging it into one of the Leak amps.

Leak TL/12

Originally called the Leak "Point One" Amplifier, the Leak TL-12 is one of the best-sounding vintage amps I have ever heard. It produces 12 watts from push-pull KT66s that are triode-connected and drive a massive open-frame output transformer. The TL/12 was made from 1949

through 1957 and there are several variations. When first introduced, many TL/12s were sold to national broadcasting organizations around the world to be used as monitor amps in stations and studios.

This amp uses terminal board construction and is also beautifully made. The sound of the TL/12 is rich, detailed and very warm. It is extremely musical and easy to listen to for extended periods. A later version of this amp, made from 1956-57, was the Leak TL/12 Plus that used push-pull EL84s. These are very sweet sounding amplifiers and sought after by British amplifier enthusiasts seeking lower powered amplifiers.

Leak TL50+

An extremely rare amp, the TL50+ monoblock was only made during 1956-58. Output power is 50 watts derived from push-pull KT88s. Front-end tubes are EF86 and 12AX7 with a 5AR4 rectifier tube. This is a great-sounding higher powered amp and will drive most available speakers. TL/50+s are very hard to find in pairs, but singles should still be picked up because you can always find someone who is looking for one to match his. Leak also produced the **TL25** and the TL25+ using either push-pull KT66s or EL34s for 25 watts of power.

Summary

In this article we examined several mid-priced but great sounding amplifiers, tuners and preamplifiers. It was not possible to list every one in this category, but we did cover the more well-known ones with higher production figures. In our next segment of this article, we will examine the remainder of mid-priced vintage hi-fi gear from McIntosh to Scott, etc.

A special thanks to Al Pugliesi (The Fisher Doctor) of Staten Island, New York and Roger Coon of Redwood City, California for their assistance with this article.

Next time in VTV:

- 2A3 Filamentary Triodes
- Scott EL84 Amplifiers
- PP 300B Amplifier
- Bookshelf Speaker
- Shootout!!!**
- 300 Watt Triode Amp

COMPUTING WITH TUBES: THE SAVAGE ART

5: THE FIRST REALTIME MACHINE

By Eric Barbour © 1999

In 1944, the U.S. Navy's Bureau of Aeronautics wanted to design a better flight simulator to help train pilots more quickly. Because the war was demanding ever-more experienced pilots, and training them with the primitive equipment of the period was slow and expensive, the Navy hoped that an electronic system could provide realistic flight controls in a simulator.

The Bureau's Special Devices Division, led by Capt. Luis de Florez, let a very special contract to MIT's Servomechanisms Laboratory. Director Gordon Brown and liaison officer Nathaniel Sage recruited two young men to oversee the project-- Robert Everett, and a brash fellow named Jay Forrester.

At the time, the Bureau had a penchant for naming its major projects after various



Whirlwind Control Panel

kinds of atmospheric disturbances. So, they called their most major project Whirlwind. Prophetically, as it grew and grew, and threatened to entirely sweep away the Bureau of Aeronautics.

As soon as work started on the simulator (called ASCA), Forrester started to work on the managers. He felt that limiting the machine to operation of a flight simulator was not a good idea--why not make it a general-purpose computing machine? Then, not only can it operate a simulator, it can process radar data, calculate trajectories, and do many other jobs for the Navy. Eventually, Forrester's pushing shifted the focus of the project. And, unfortunately, its cost grew. As the war ended, and the Bureau became the Office of Naval Research in 1946. And as the beast occupied a very large room in MIT's

Barta Building, starting with first layout in August 1947.

The ONR was very unhappy by 1948. Their own Mathematics Branch warned that the MIT team was not sufficiently experienced in advanced mathematics. Yes, at the time, Boolean algebra and binary arithmetic were regarded as extremely complex and obscure fields of study. And Forrester's team did receive remarkable freedom during the design and construction phase. The enormous assistance they received from Sylvania was a big help.

One thing that Sylvania got out of the Whirlwind project was priceless. The engineers were trying to use 7AD7 radio pentodes in the logic circuits. Unfortunately, these tubes died very quickly, because their cathode current was cut off much of the time. Sylvania engineers discovered the cause: impurities in the nickel cathode tubing. Ordinary radio circuits didn't see this, because the tube conducted some current all the time. For digital use, though, a special high-purity cathode was developed. Thus was born the 7AK7 pentode, the first electronic device ever developed specifically for digital logic applications.

1948 was a turning point. The ONR was now balking at the endless requests from the Whirlwind team for more and more money. And there were endless technical difficulties with the special Williams memory tubes being fabricated in MIT's own glassblowing shop. These complex tubes each had two electron guns, one for writing and the other for reading. Each tube cost more than \$1000, in 1950s dollars. And Whirlwind needed 16 at first, for 256 words of memory. Eventually the memory was expanded to 2048 words. The project might have died then, if Forrester and Smith had not managed to arrange some further support from the U. S. Air Force. So, they eventually got enough money to get the machine running programs by early 1950.

Whirlwind was a 16-bit machine, the first to have a word length based on a factor of 8 (which is standard practice today). It had a hardware multiplier,

which occupied a great deal of space. Overall, it was akin to a crippled Motorola 68000 in its basic layout--occupying 3100 square feet.

The number of "firsts" that Whirlwind can claim is considerable. Since it was the first digital computer to get an analog-to-digital converter, it was the first to be used in real-time data acquisition. And it was the first computer to be capable of generating real-time graphics on its 14" CRT display, which could be modified with a handheld "light gun". When the Williams tubes were abandoned, Whirlwind became a pioneer of core memory in 1953. A small computer, called the Lincoln Memory Tester, was built to exercise the core module. This tester was built by some MIT students who went on to found Digital Equipment Corporation.

More significant, Whirlwind was so successful that it led to the formation of MIT's Lincoln Laboratory. Which, in turn, used Whirlwind's basic design as the kernel of the biggest, most expensive and most complex electronic computer system every built. That Cold War monstrosity, a major user of computing tubes in the 1960s, will be discussed in the next installment.

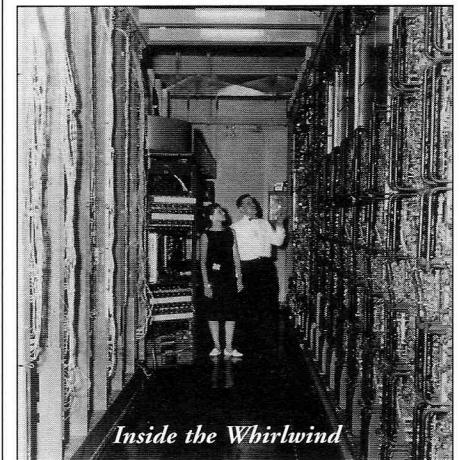

Inside the Whirlwind

References:

1. **Project Whirlwind: The History of A Pioneer Computer**, Kent C. Redmond and Thomas M. Smith, Digital Equipment Corp. Press, 1980.

Many thanks to the staff of the Computer Museum History Center and to Les Earnest of Stanford University for their assistance with research. The Computer Museum is the current owner of the remains of Whirlwind.

Uncle Eric's Tube Dumpster

The 6688/E180F

By Eric Barbour
© 1999

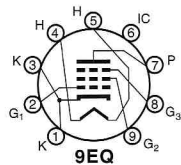

For obvious reasons, the hard core of tube DIYers has started to use high-transconductance frame grid tubes for small-signal gain. Although they can vary in linearity, just as more conventional small-signal types do, frame grids offer low plate resistance and (hopefully) lower microphony.

Yet again, we see iron tradition in the relatively staid world of the SE amp. The tendency has been to chase after the highest Gm devices (and only glass ones at that), which makes them scarce and expensive. The current fad for the 417A and 437A triodes and 7788 pentode, not to mention recent demand for the obscure Russian 6C15 pentode, are driven by DIY peer pressure and conformity. And those particular tubes always were expensive; now that they are out of production, their prices are skyrocketing. Meanwhile, very good tubes languish in great piles in warehouses.

One of the first frame-grid pentodes was the Western Electric 404A (1948). Widely used in telephone microwave-multiplex equipment, it became an important device for IF amplification. It occupied little space, making it suitable for mobile radios. As made by other manufacturers, it was known by its EIA number 5847.

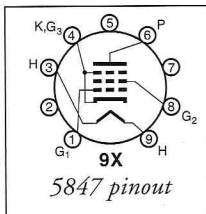

5847 pinout

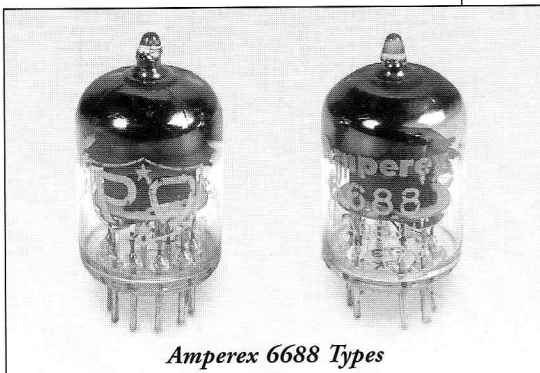

Amperex 6688 Types

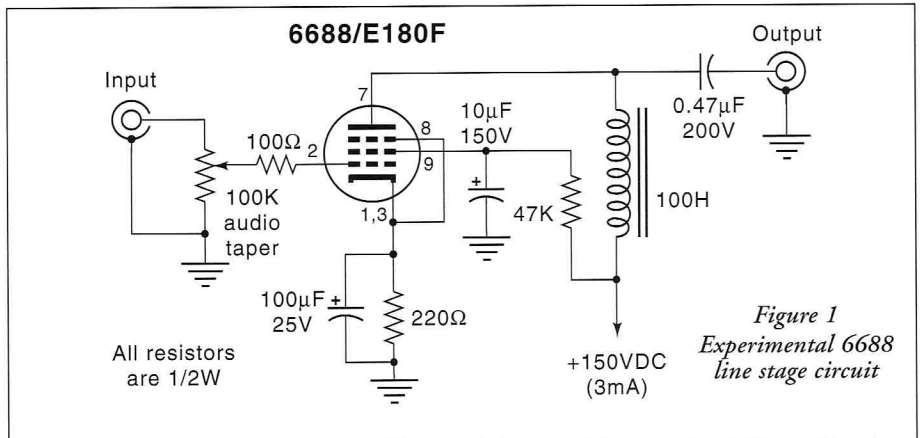

Figure 1
Experimental 6688
line stage circuit

Of course, Philips wanted a piece of this business, so they introduced the E180F in 1956. Unfortunately, they put a different pinout on it, then had to promote it for NEW designs. Still, both in Europe and in the American Ampex form 6688, it got sockets in a variety of military and civilian radio equipment.

Five years later came the 7788/E810F, also introduced by Philips. The obscure 7788 was a VERY tough tube to manufacture. It represented the outer limits of glass-tube capabilities, with its Gm of 50,000, and it was never as widely used as 6688s due to its high price. So you can bet that we will never see 7788s made, ever again.

Before you say "so what," bear this in mind: Getting such a high Gm means that you must have the grid VERY close to the cathode. In this case, less than 1000 microns away—much less than the thickness of this sheet of paper. This a tough feat to achieve in a planar triode... and unimaginable in a conventional glass pentode! Eindhoven's reject rate on the 7788 production line must have been astronomical.

Our tests have shown a high degree of linearity in a typical 6688—on a par with 6DJ8s and 6922s. Yes, even though it is a pentode.

Figure 1 is a suggested experimental circuit for a super-high-performance line stage using the 6688. You may have to do a little tweaking on your own with this design to get maximum performance. If you use the primary of an old push-pull EL84 amp's out-

put transformer for the choke, you can build a stereo preamp with this circuit for less than \$50.

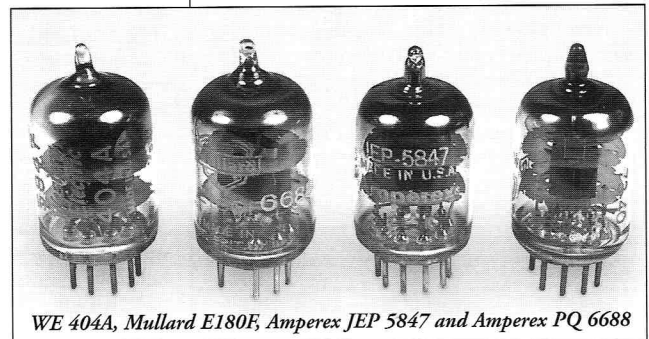

WE 404A, Mullard E180F, Amperex JEP 5847 and Amperex PQ 6688

Dealers are charging up to \$350 apiece for high-Gm triodes like the 437A, and about \$100 for 7788s. Yet those same dealers are stuck with mountains of 1980s surplus 6688s, which nobody wants because they don't have the highest Gm ratings in the tube manuals. So, don't fall for "Tube Manual Snobbery." Great sound can be gotten from the 7788's smaller brother, at peanut prices. Yes, even though it is a pentode, and even in spite of its moderate transconductance. High Gm is NOT a magic pathway to nirvana.

6688 Specifications

Heater Voltage	6.3V
Heater Current	0.03 amp
Max Plate B+	210V max
Max Plate Diss.	3.0 watts max
Plate Resistance	0.09 megohm
Transconductance	16,500 micromhos
Grid No.2 Volts	175 max
Grid No. 2 Diss	0.9 watt max
Grid No. 1 -Bias	-50V max
Cathode Current	25 mA max

ASUSA A-4 Amplifier

VTV Kit Review

By Charles Kittleson © 1999 All Rights Reserved

One of the more prolific producers of tube audio kits today is ASUSA of Seattle, Washington. Recently, they introduced a line of USA-made kits featuring point-to-point wiring, high-quality powder coated steel chassis and beefy, US made transformers. Their kit line includes a number of basic amps, integrated amps, line stages and phono-preamps. For this article, we chose to review their Model A-4 stereo amplifier kit. The A-4 is a 30 watt RMS per-channel basic stereo amp, featuring Ultralinear-connected push-pull EL34s driven by two 12AU7s dual-triodes per side, in the classic Williamson circuit. AC voltage is rectified by silicon diodes. The power and output transformers are huge and are custom manufactured to ASUSA specifications. A filter choke is mounted on the front of the chassis. (The choke in front of the chassis is now painted black, so it blends in with the overall cosmetics of the amp.)

In the 1950s and 1960s, many quality kits were produced by Heathkit, Knight Kit, Dynaco, Lafayette and others. The signs of a well-designed kit include a thorough assembly manual, with an accurate parts list, proper marking of parts, and diagrams that go through the assembly process, step-by-step. The ASUSA Kit came with a 15 page assembly manual that included: tips on assembly and wiring, proper soldering procedure, amplifier specifications, circuit description, step-by step assembly instructions, wiring instructions,

initial power-up and bias adjustments, performance test procedure, troubleshooting guide, parts list, schematic diagram and mechanical assembly diagram.

How Did it Go Together?

The assembly of the A-4 was performed by Ken Kawamura, a technician for VTV. Ken's comments are as follows:

1. Helpful hints and proper solder procedures in the kit manual are beneficial for the first time kit builders. Soldering codes (NS - not to be soldered yet) were helpful, but they left the soldering code out in some assembly steps, which left you wondering what to do.
2. Chassis hardware, resistors, capacitors and wires came in separate bags.
3. A soldered parts placement pictorial figure in the assembly manual would be very helpful. Heathkit had these in their manuals, which aided in assembly and reduced wiring errors.
4. Insulated sleeving or shrink tubing was not supplied. The assembler will have to purchase this at an electronics supply store. Screws to mount the rubber feet were missing from the package.
5. A few areas of the assembly instructions were confusing. There were a few labeling errors, such as specifying a 1 watt resistor where a two watt was required. Tech support had to be called a few times to clarify instructions. Fortunately, ASUSA tech support was helpful and easy to talk with.

6. Some minor things were noted after the amp was finally assembled according to the supplied instructions. The power pilot light went on when the power was shut off and went off when

the unit was powered up. Wiring of one of the bias electrolytic capacitors was correct in the schematic, but incorrect in the assembly instructions. This caused a reversal in polarity so that one of the bias capacitors failed. We had to replace that cap and wire it correctly. Wiring for the bias adjustment pots for one channel of the amp was reversed when compared to the other channel.

For an experienced kit builder, this project should take about 16-20 hours. For a rank beginner, about 30 hours may be required due to some potential confusion in the assembly and wiring instructions. It is important to check and re-check wiring to insure that your work is correct when compared to the schematic. The supplied schematic is correct, but a few of the assembly instructions were incorrect. If the assembly instructions conflict with the schematic, refer to the schematic as the correct way. ASUSA says the A-4 assembly manual has been rewritten and the step-by step instructions have been made easier for the beginner. In addition, the resistor color codes have been added to the instructions for ease in identification.

Sound Quality

Once assembled, we hooked the A-4 amp up to our speakers and a CD player. Speakers used were either the Klipsch Chorus Is or B&W DM110s. The A-4 amp has relatively tight bass for an EL34 amp, mids are full and highs are sweet and extended, while not being overly bright. This amp has good color and overall tonal balance. Acoustic instruments sounded realistic without any bloating of the mid-frequencies. It was very neutral sounding and easy to listen to for extended periods of time. The A-4 has enough power to be used with modern acoustic suspension speakers having a sensitivity rating of 89+ dB/1 watt/meter. Input sensitivity is high enough for you to plug a CD player or tuner (with volume control outputs) straight into the amp without using a pre-amp.

Like all new equipment, break-in is required for things to smooth out. We ran the amp for about 30 hours and noted an overall sonic improvement in the mids and highs which made the amp sound more musical. Sonically, the A-4 is superior to any similar-priced tube or solid-state amplifier on the market.

Why would you want to go through the trouble of upgrading a rusty old Dynaco Stereo 70 you found on EBay, when the ASUSA A-4 will sonically outperform the ST70 and many other vintage EL34 power amps? This is due in part to the all-triode



ASUSA A-4

front-end circuit of the A-4, as well as the A-4 output transformers which are more balanced and neutral sounding than the Dynaco A-470s. With the A-4, you can start with a new chassis, new parts and high-quality transformers instead of trying to undo some 1960s kit-builder's flaky soldering joints on butter brickle circuit boards. In addition, replacement parts for vintage amps, such as high voltage quad capacitors, are difficult, if not impossible, to find.

Sonic Improvements and Upgrades

Many audio enthusiasts consider the EL34 their favorite output tube because of its detail, power and romantic sound. In addition, the EL34 is in current production by several manufacturers and affordable. The A-4 comes equipped with a quad of Svetlana EL34s output tubes. In our VTV listening comparisons, the Svetlanas come very close to the sound of the original Mullard EL34s from the 1960s. N.O.S Mullard EL34s are now \$75-\$150 each or more, and hard to find in matched quads. I suppose you could notice some improvements by spending another \$300 or so on Mullard EL34s, but significant sonic improvements can be made by substituting higher quality NOS 12AU7s. Good 12AU7 candidates include the Brimar ECC82, Mullard ECC82, Siemens 5814, Telefunken smooth plate ECC82, RCA 12AU7 cleartop, Radio Technique (France) 6189 or 5814 and CBS 7730.

As noted above, input sensitivity is high, so if your preamp has any hum, this amp may pick it up. The speaker terminals are a little on the small size and will not accept 8 gauge spades, but they can

be replaced with either 5-Way speaker binding posts or larger speaker terminal plates with minor modifications.

If you can build this kit, you will also have developed the skills to conduct circuit component upgrades. Some improvements can be achieved by changing the stock .1 uF coupling capacitors to Hovland MusiCaps, UltraTone Capacitors or other upgrade caps of your choice. The premium capacitors will make the amp sound somewhat bigger and more extended. Additional improvements can be made by removing the silicon power supply diodes and replacing them with fast switching FRED diodes in the TO-220 case. Lastly, the B+ filtering could be doubled from the two 20 uf @500 V to two 47 uf @ 500 V for a little more bass. Higher quality electrolytics could also be used to add an even smoother sound. ASUSA tells us that there is no warranty on the kit, but transformers and all other components are warranted for 90 days.

Product Rating

At a base price of \$549, the ASUSA A-4 amplifier kit is an excellent value for the money. A chrome-plated chassis and tube cage are optional at extra cost. If kit builders take time to carefully assemble this unit, they will be very satisfied with the results. If you need at least 20-30 watts to drive your speakers, most single-ended amps will not work well. The A-4 has ample power to drive most moderate efficiency (89 dB+) bookshelf speakers with ease. This kit is perfect for the person who is bored or irritated with solid-state amplification and wants to buy their first tube amplifier. In addition to saving hundreds of dollars, the kit builder will

have fun building this kit and will be able to tell their friends "I built it myself."

All of us at VTV agree that the A-4 is a qualified BEST BUY tube amplifier kit. The ASUSA A-4 has the most bang for buck of any tube amp kit currently on the market in the USA. In addition, this kit is ideal for customers in foreign countries due to the multi-tap power transformer. 230, 117 and 100 volt AC taps are available on the stock AC power transformer.

Advertised Specifications

- Frequency Range - 25-25,000 Hz @ 1 dB
- Distortion - Less than 1% at 30 watts
- Hum and Noise - Down 70dB
- Sensitivity - Less than one volt input for 30 watts output
- Line Input Impedance - 500K Ohm
- Size (w/d/h) - 14" x 10" x 6.5"
- Net Weight - 34 lbs (15.5 Kg)
- ASUSA-Kit, 6717 NE 181st Street, Seattle, WA 98155 USA (425) 481-8866**

ASUSA A-4 Measurements at the One Electron Laboratory

The ASUSA A-4 comfortably exceeded its advertised specifications. The maximum output power before clipping was 36 watts and THD was .55% at 30 watts. The high frequency response varied between channels: the right was -1dB at 47.6KHz, the left was -1dB at 58.6KHz. The low power, low frequency response was essentially flat to 20Hz, although showed a 1dB rise at 10Hz - a sign of potential low frequency instability. At 30 watts output, the lowest frequency before saturation was 23Hz, which is quite good and a testimony to the quality of their large output transformers. The noise measurement was better than -74dB (referenced at 30 watts) and was not dominated by hum. Sensitivity was 0.56Vrms in for 30 watts out - a bit more sensitive than most amps, but still reasonable. A "passive pre-amp" would work well here.

The harmonic distribution was typical for a class-AB1 push-pull amp - higher odd harmonics. At 5 watts and above, there were fairly high amounts of high-order harmonics - at least up to 17th order. Crosstalk between channels was a bit marginal - rising to -46dB at 20KHz. At 150Hz it was at a minimum of -76dBm but rose to -55dB at 20Hz. Shunting the main power supply filter electrolytic capacitors (C22 and C23) with 100uF 500V capacitors reduced the low-frequency cross-talk by over 10dB.

John Atwood, VTV Tech Editor

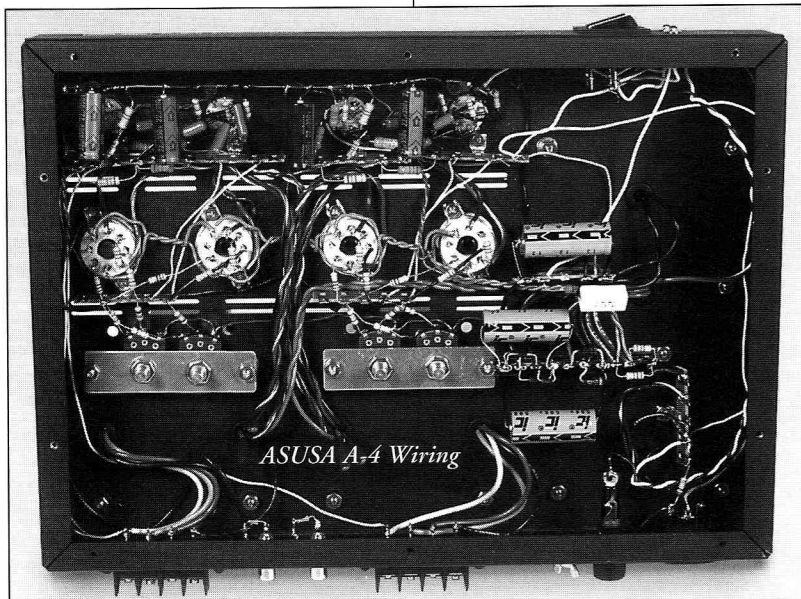

Kludge 4 Single-Ended OTL Headphone Amplifier Project

By Scott Dorsey © 1999 All Rights Reserved

For studio use, I found myself in need of a headphone amp that could drive high-Z studio headphones like the AKG K240, which require a substantial voltage swing to get reasonable levels. On the other hand, I also found myself in need of a headphone amplifier that could drive low-Z headphones like the Grado, preferably with several headphones paralleled together.

Out of this need came the Kludge-4 headphone amplifier. This is a simple two-tube headphone amplifier with a high-transconductance regulator tube used in cathode follower mode for fairly wide voltage swing and a very low output impedance. It is, in fact, even possible to drive the 16 ohm Quad loudspeakers with this amplifier if one is willing to suffer some reduction in low end. (I cannot recommend actually doing so, but the fact

that it can be done is something impressive in itself).

The design can be built on a conventional BUD chassis with point to point wiring. Both tubes take standard octal sockets and are readily available from standard sources from Triode Electronics to Antique Electronic Supply. Readily available components were used in every case, except that of the power supply transformer.

Power Supply

The power supply is called upon to provide 90V at substantial current (about 300 mA) for the output tubes, 260V for the input tubes, and 6.3V at three amps for the filaments. The original design used a custom-built transformer, but you can use individual transformers for the output stages, so long as you adjust the series

resistors to get the correct voltages. For example, you could use a 115V isolation transformer to supply the B+ for the output tube, and increase the value of the 18 ohm resistor proportionately. Capacitors are heavily derated in voltage in this design to allow you to do this.

Let's take the output stage supply first. The 90VAC output of the transformer is rectified and run through two 470 uF 200V capacitors in parallel, then through a smoothing resistor, and to a set of three more 470 uF 200V capacitors. These values were chosen because they are common items in PC power supplies and are therefore cheap commodity items (and can even be scrapped from old computers by the adventurous), and they are about the minimal capacitance acceptable for good hum rejection and good sound quality. Some tests were made with regulated supplies which gave better noise rejection but somewhat grainier sound, so I decided to go back to the simple brute force approach. Notice those ceramic caps there? They are bypass caps to stiffen things up at RF a bit. By using them, you can get away with using cheaper bridge rectifiers and not having any sonic degradation from some of the switching noise, though they aren't really essential.

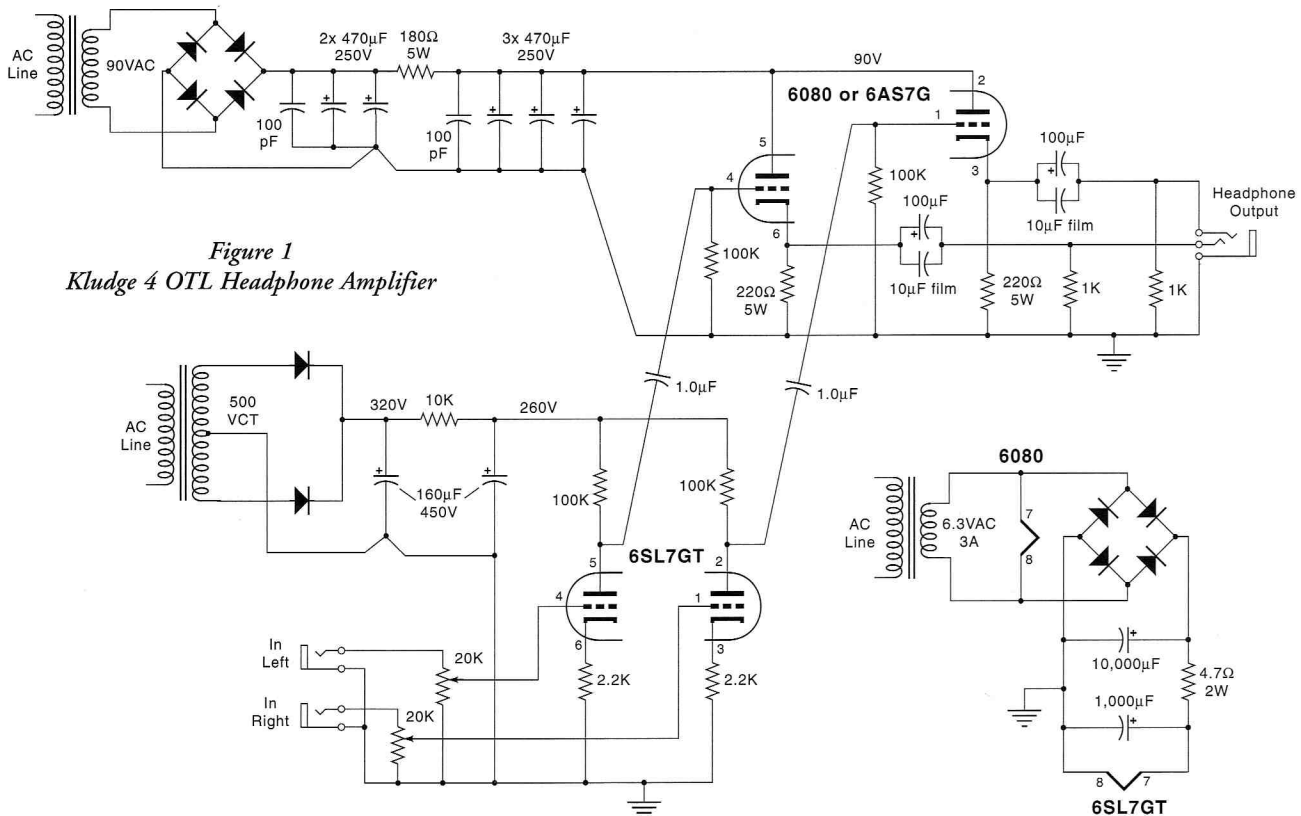
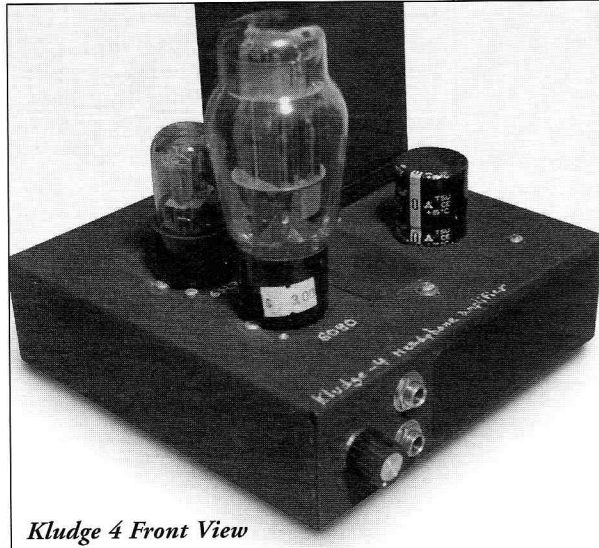

Figure 1
Kludge 4 OTL Headphone Amplifier

O T L H E A D P H O N E A M P P R O J E C T

The input supply is similar, just higher voltage and much lower current. A 600 VCT transformer is half-wave regulated, run into a 160 uF 360V capacitor to ground, a 10K resistor, and then another 160 uF cap. These capacitors also are commodity items; the Nichicon

from 10K to 100K will work, so see what quality pots you have on the bench. (*Pots below 50K may load down some tube pre-amps.-Tech Ed.*) I can strongly recommend the Noble and higher grade Alps pots which are available for reasonable prices and have excellent tracking between channels. With headphones, mistracking that would be inaudible on speakers can become painfully obvious due to the exaggerated imaging. The pot drives half of a 6SL7GT acting as a capacitively coupled amplifier, with a gain of about 50.



Kludge 4 Front View

photoflash caps of these values are intended for use in disposable cameras and can be obtained at very low cost from Kellner Capacitors or from scrapped disposable cameras at your local photo lab.

The filament supply is a bit odd here. The 6.3VAC output from a transformer is used to directly feed the filament of the 6080 tube, which in itself pulls 2.5A, a very substantial amount of current. Some of it, however, is rectified, smoothed and used to drive the filament of the 6SL7. Why, you ask? Some of the available 6SL7s, like the CBS and Sovtek tubes (but not the GE or Raytheon tubes) have substantial filament-to-cathode leakage. This causes substantial hum induction if the filament is run on AC.

Input Section

The input section is a simple RCA jack going into a passive volume control. I picked a 20K control here, but anything

(since after all, tubes don't come in PNP versions). So we're back to the old friend, the simple cathode follower.

This is a very hot-running cathode follower, using a common 6080 regulator tube. The output (which has a maximum power transfer impedance of around 40 ohms, just perfect for driving Grados), is capacitively coupled to the headphone jack, and we are using a 100 uF aluminum electrolytic with a 10 uF

film bypass cap to remove most of the electrolytic nastiness. If you are sufficiently rich and have sufficient chassis space, using 110 uF of paralleled film caps would be a very good idea here, and the total voltage across it is less than 10V so you can get away with smaller caps.

The slight DC offset across the capacitors minimizes problems with the electrolytic nonlinearities near zero. Plus, the

1K resistor to ground keeps that offset at all times (as well as reduces popping by charging the cap up quickly even with no load on the amp). These, combined with the bypass caps, do as much as possible to reduce the ill effects of the electrolytic, and indeed with A/B tests between large film cap arrays and the bypassed electrolytic, the sonic difference was found to be small (although still audible).

Construction Hints

I have built several of these in small Bud chassis, and one of them in the case of an old IBM PC power supply. The transformers and the output tube are the limiting factors here (and yes, before you ask, you CAN use a 6AS7 in there, though it will sound different) in terms of size.

Because even a slight amount of hum can be a major problem with sensitive headphones, be very careful about your grounding scheme. You will need to use single point grounding, and eliminate all ground paths through the chassis. In a perfect world, this would mean that the chassis was connected to the signal ground at only one point. In reality, unless you use isolated ground connectors, it will be connected to the ground at each one of the input and output jacks, and that is acceptable. Nevertheless, you want to avoid adding any additional ground paths. Don't just use the loops around the tube sockets as grounding points, but use isolated standoffs and tie them together at a single grounding point.

Overall, this is a design that has been optimized for good sound at very low cost, and is a good performer at driving a very wide range of different headphones. It can drive to high levels but does not sacrifice power for sound quality.

This headphone amplifier project is for personal use only; no commercial sales or production of this design is permitted.

Mr. Dorsey (kludge@netcom.com) owns and operates Kludge Audio, 217 Thomas Nelson Lane, Williamsburg, Virginia 23185, a small studio specializing in classical and acoustic music. He has several engineering degrees from Georgia Tech, and has been nominated for Grammys several times. This and a dollar will get you a cup of coffee. He is old enough to remember when compactrons were going to be the salvation of the electronics industry. He does not own a cat.

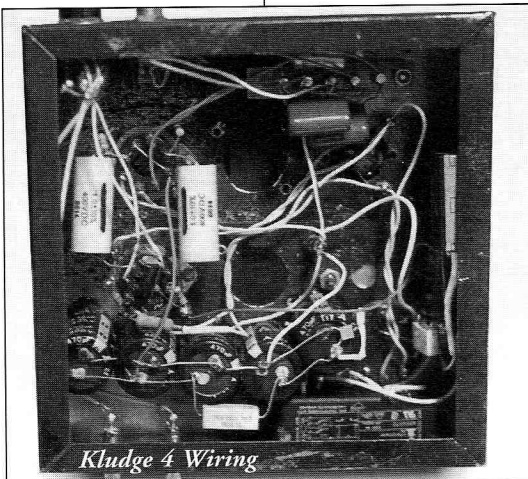

Kludge 4 Wiring

VTV Listens to Signal Capacitors

By Charles Kittleson

© 1999 All Rights Reserved

Although many capacitor manufacturers make claims on how great their capacitors sound, few subjective listening evaluations have ever been published. At VTV, we have experimented with many different types of capacitors and have formed some listening impressions. There are several high-quality capacitors on the market and the selection is growing continuously. *Due to time constraints and other factors, there is no way we could possibly evaluate all brands of capacitors in this discourse.* To help our readers understand some capacitor sonic differences, we listed a few capacitor types we've had good results with. These may be good choices for you, depending on the application.

For our listening evaluations we used two amplifiers, an Antique Sound Lab A-4 push-pull EL34 power amp and a custom single-ended 300B amp with One Electron UBT-3 3K output transformers. In addition, we used a vintage Dynaco Stereo 70 and a Fisher 500C receiver. *For this test, we connected the capacitors into the coupling circuit between the driver tube and the output tubes.*

Some tips: *Remember to wire signal capacitors so that the inner foil points toward the output and the outer foil points toward the input.* The outer foil was sometimes identified with a printed band on older caps and normally is on the left side of the capacitor when reading the printed information on the cap. If you wire the outer foil to the output side, the sound will be muffled and rolled off. If in doubt, try reversing the leads. Also, avoid using the same brand and type of capacitor throughout the amplifier. Mix and match capacitor brands and types (oil, film, paper, etc.) like you would add spice or seasoning in your favorite dish.

Illinois Capacitor MWR - Metallized Polyester

John Atwood, VTV Technical Editor, has measured and tested IC-MWR capacitors and noted that even though they are not super fast and have slightly higher

ESR, they are a good sounding capacitor. Earl Yarrow, Steve Parr, and other vintage hi-fi equipment restorers say that ICMWRs sound very warm, but detailed and musical. The IC-MWR sonics and speed are very close to the original designers intentions for classic equipment. IC-MWR caps are an excellent choice if you are restoring any type of vintage tube gear or re-capping crossovers in vintage speakers.

716P SBE Orange Drop

The venerable orange drop has been around since the 1950s. Orange Drops are now made by SBE. For years, it was used as a quality replacement cap in radios, TVs and amplifiers. Many manufacturers, including Fender, used them in production. There are several varieties of Orange Drops, but the highest quality is

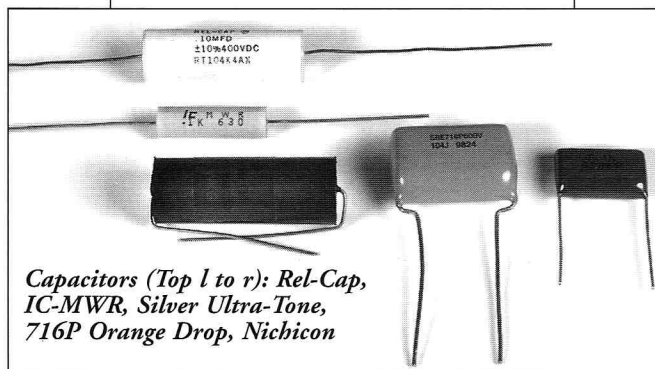

Capacitors (Top l to r): Rel-Cap, IC-MWR, Silver Ultra-Tone, 716P Orange Drop, Nichicon

the 716P polypropylene film and aluminum foil with solid copper leads. Sonic qualities of Orange Drops depend on the application. In hi-fi coupling stages, they can have a tubby bass response and somewhat smeared highs. However, the mid-frequencies can be big and musical. This can work well in guitar amplifiers and in certain hi-fi applications.

Nichicon Metallized

The Nichicon metallized polypropylene capacitors are an inexpensive alternative to some of the other capacitors listed here. They feature radial leads, are compact and durable with a hard epoxy coating. Sound quality is detailed, but a little on the bright side. Some feel that a good application would be upgrading guitar amps and "darker" sounding amplifiers or preamps. They are not as "full bodied" as some of the other caps listed here, but are worth experimenting with due to their bargain pricing.

Rel-Cap Polypropylene Film and Foil

Rel-Cap has been selling precision audio capacitors for several years and has a

good following. Their product line features a huge variety of values and types of precision capacitors using foil and film metallized film, teflon, etc. We listened to the polypropylene foil and film types and noted them to be accurate, fast and very detailed sounding, especially in high-end audio designs. In fact, they are used by many OEMs of tube and solid-state audio equipment. Note: Rel-Cap also markets the popular Multi-Cap capacitors. If you plan on using Rel-Caps in vintage audio gear, the foil and film types seem to be more desirable for maintaining the original vintage sound.

Hovland Musicap - Polypropylene Film and Foil

Hovlands are attractively packaged, have silver plated stranded leads and are very well-made. They are available in most standard values for bypass, coupling and speaker crossovers. Many amp repair customers specify Hovland MusiCaps when restoring their tube amplifiers and preamps. Sonic improvements with Hovlands include smoother response and improved bass performance. In addition, unlike many modern caps, they are easy to listen to and tend to have a sweeter high frequency performance than other some premium caps.

Ultra-Tone - Silver Foil in Oil

Ultra-Tone Silver Foil in oil-capacitors are made in England using 98% silver foil wound with high-quality paper impregnated with non-toxic, mineral oil as a dielectric. Ultra-Tone Caps are less likely to have electrical or oil leakage when compared to other modern oil types. Ultra-Tone Caps are sealed with epoxy on both ends and feature solid-silver plated OFC axial leads.

Ultra-Tone Silver Foil caps seem to have excellent musical realism." The sound presentation is rich, vibrant and liquid. Other modern and vintage paper in oil caps can sound darker or veiled by comparison. Silver Foil Ultra-Tone-Caps are a good choice for single end triode amplifiers, push-pull power amplifiers, tube preamps, power supplies and premium loudspeaker designs.

This short article is a *subjective evaluation* of some capacitor types we like. It by no means is exhaustive and we plan to feature more articles on capacitors in future issues of VTV.

Vintage Microphones and Speakers in Japan

By Charles Kittleson
© 1999 All Rights Reserved

High quality speakers have been a hot commodity in Japan for over 30 years, especially certain brands. Like anything vintage or classic, there is a certain mys-

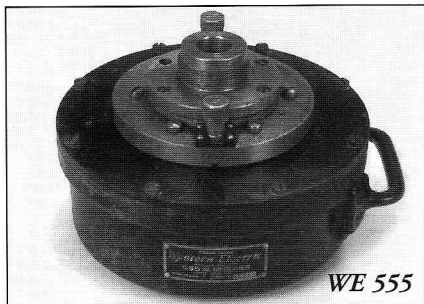

WE 555

tique surrounding brands like Tannoy and Western Electric. There are literally dozens of shops in Tokyo and other Asian cities that specialize in the sales of vintage audio equipment. For the most part, classic audio equipment in the US is not considered a status symbol as it is in Japan.

Western Electric speaker components designed for movie theater applications are especially valuable. These were never sold to the public, but were leased to theaters for a certain time period. When the lease was up, speakers and equipment were occasionally sold to theater owners and operators.

Speakers in large cabinets, such as EV Patricians, JBL Hartsfields, Jensen Imperials, etc. usually turn up at auctions, estate sales, via older hi-fi enthusiasts and word of mouth. Fast-buck dumpster divers typically scrapped lesser model wood cabinets to get at the raw drivers and crossovers because they are much easier and cheaper to ship to Asia. Consequently, many cabinets wound up as firewood or mulch. Quality speakers in original cabinets command super-high prices in Japan because they are very expensive and troublesome to ship.

For top prices, the speaker cone must be original with no holes or repairs. Non-factory reconed speakers are not knowingly purchased by collectors and in some cases are even difficult to sell to end users. Speakers are also very difficult to ship. Typically, they must be mounted on a wooden baffle board and double-boxed.

Note: The prices listed below (in Japanese Yen) were derived from *MJ Magazine*. Due to time and space constraints, the list below is not all-inclusive.

Speakers

AR	
AR-1	¥200,000 pr
Altec	
A-4	¥1,250,000 pr
A-5	¥780,000 pr
A-7	¥430,000 pr
Model 19	¥480,000 pr
288(B, C)	¥200,000 pr
311-90	¥180,000 pr
515B	¥150,000 pr
803B	¥240,000 pr
604A	¥430,000 pr
604 8K	¥360,000 pr
755A	¥200,000 pr
802B	¥75,000
803B	¥130,000 pr
806 (8A)	¥70,000 pr
1005	¥160,000 pr
Electro-Voice	
Patrician 800	¥2,200,000 pr
SP-12	¥70,000 pr
SP-15B	¥120,000 pr
12TRXB	¥70,000 pr
15TRXB	¥160,000 pr
T350	¥90,000 pr
JBL	
Hartsfield	¥3,000,000+pr
Paragon	¥1,500,000 ea
C31	¥1,600,000 pr
C34	¥580,000 pr
C36	¥380,000 pr
D-130	¥80,000 pr
D-130A	¥110,000 pr
075	¥70,000 pr
175-DLH	¥110,000 pr
375 (grey)	¥290,000 pr
4344	¥1,240,000 pr
LE-85	¥80,000 pr
Jensen	
A-12	¥120,000 pr
G-600	¥550,000 pr
G-610	¥980,000 pr
H-222	¥150,000 pr
M20	¥650,000 pr
QUAD	
ESL-57 Electrostat	¥180,000 pr

ESL-63 Electrostat	¥300,000 pr
RCA	
LC-1A 15 inch coaxial	¥580,000 pr
Tannoy	
12 inch gold	¥480,000 pr
15 inch gold	¥550,000 pr
15 inch red	¥850,000 pr
15 inch silver	¥900,000 pr
Autograph	¥1,780,000 pr
Westminster	¥650,000 pr
York	¥850,000 pr



WE Studio Ribbon Mike

University	
6201	¥70,000 pr
Western Electric	
TA 4151A 12 inch woofer	¥750,000 pr
TA-4181A 18 inch woofer	¥600,000 pr
WE 21A horn	¥600,000 pr
WE 22A horn	¥480,000 pr
WE 555 horn driver	¥490,000 pr
WE 594A horn driver	¥900,000 pr
WE 597 horn w/driver	¥1,200,000 pr
WE 728B 12 inch speaker	¥650,000pr
WE 755A 8 inch speaker	¥480,000 pr
Microphones	
Altec	
639B	¥1,500,000
EV	
556 Elvis mike	¥850,000/pr
RCA	
44DX	¥2,500,000
77DX	¥2,300,000
Neumann	
M49	¥17,000,000
U47	¥9,500,000
U67	¥5,800,000
Western Electric	
7A	¥9,000,000
9A	¥10,000,000
639	¥1,600,000
640	¥7,500,000

The Audio Test Bench

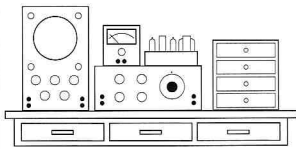

by
John Atwood

Power Supplies

© 1999 All Rights Reserved

So far our Audio Test Bench series has concentrated what is considered traditional test equipment: meters, scopes, analyzers, etc. In this issue, we will cover one part of the infrastructure of any test bench: power supplies. These can range from the simplicity of a current-limiting light-bulb all the way to computer controlled regulated supplies. Somewhere in between will be the ones best suited for your test bench.

A power supply is defined here as a system of delivering power – AC or DC – with at least one controlled parameter, typically voltage or current. Many modular power supplies exist for use inside equipment and some of them are usable as test equipment, but most of the supplies considered here are self-contained units intended for bench-top use.

CAUTION: Many of the supplies described here can have exposed high voltage terminals! Exercise care to avoid lethal shocks!

AC Line Power Supplies

A means of adjusting or controlling the AC line power to a unit under test is very handy for initial bring-up (the “smoke test”) or for diagnosing power problems. In most cases, a power generator is not needed, just a scheme for controlling the voltage and/or current to the load. One exception, rarely encountered on the audio test bench, is the need to generate a different power line frequency, such as 50Hz in North America, 60Hz in most other places, or 400Hz to run surplus military avionics.

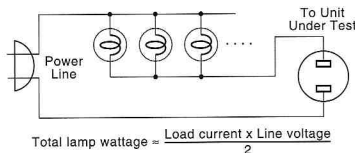
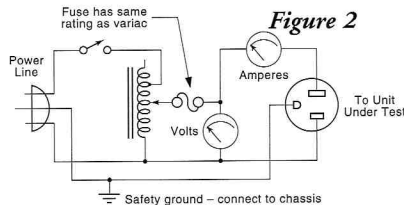

Figure 1

One of the simplest and oldest methods of limiting AC power to equipment is to use one or more light bulbs in series with

the load, as shown in figure 1. When cold, a tungsten filament has low resistance, but as it heats up, the resistance increases, thus serving to limit the current flow to the load. The brightness of the bulb also is a visual indicator of the relative current flow. It is hard to get accurate current control with light bulbs, though, and nearly impossible to bring up a load slowly from zero volts to full voltage.

A solution to the slow bring-up problem is the adjustable transformer, commonly known as the Variac. The word Variac was the trademark of the General Radio Co., who invented it in the early 1920s. However, with the decline of General Radio (later named GenRad and eventually QuadTech) and the very common use of the word, variac has essentially passed into common usage. A variac is



a toroidal transformer with a carbon brush that rotates as the control knob is turned, giving a smoothly varying AC voltage from 0 to typically 120% of the incoming line voltage. A variac does not inherently regulate the AC voltage or current, but when used with a voltmeter and ammeter, allows easy manual adjustment. Raw (unpackaged) variacs are easy to find in surplus – just check the rated voltage and current and make sure it is not a 400Hz unit! Figure 2 shows a good way to make a bench-top AC supply using a variac. The fuse is necessary, since the variac does not limit the current and will be damaged if the load short-circuits. Photo 1 shows a nice bench-top Variac by General Radio with voltage, current, and power metering.

One of the main uses of a variac for tube enthusiasts has been the slow bring-up of old equipment in order to “re-form”

their electrolytic capacitors. (see VTV, issue 3, page 26). Basically, the equipment is plugged into the variac, turned on, and the AC voltage slowly raised over a period of minutes to an hour or more. The gradual rise in DC voltage across the filter capacitors re-forms them and can bring them back to life. There are two problems with this method, though. One is that it is essentially impossible to check which capacitors are drawing too much current and need slower forming. You just



Photo 1: Gen-Rad Variac

increase the voltage and hope that nothing blows up! On the other hand, equipment that has been used recently often needs no forming at all. The other problem concerns equipment with vacuum tube rectifiers. A tube rectifier will not start conducting until its heater voltage is at least 1/3 to 1/2 its rated voltage. If a variac is used, no forming takes place until the line voltage is at least 50 volts (for 120 volt systems). Then all of a sudden voltage is applied to the capacitors in a rush, often damaging the rectifier and maybe even the capacitors. Tubes running at below-normal heater voltage are especially prone to cathode stripping in this situation. The solution is to either plug-in a solid-state replacement rectifier or form the capacitors with a DC supply as explained later.

Unregulated DC Supplies

Direct-current (DC) power is needed for a variety of test bench functions: powering solid-state circuits and digital logic, tube heater supplies, and tube plate (B+) supplies. Regulated supplies, described in the next section, are usually the preferred, and sometimes the required type of supply, but in some cases can be prohibitively expensive. An unregulated supply with a voltmeter to monitor its output can be very handy for temporary test set-ups that need a lot of voltage or current.

A commercial adjustable high-voltage supply is shown in Photo 2. It is basically a conventional capacitor-input supply using two 5R4GY rectifiers, with the



Photo 2: Unregulated Tube-Type Power Supply

high-voltage transformer driven by a variac. A filament transformer wired ahead of the variac supplies the 5 volts for the rectifiers as well as 6.3 volts to the front panel.

If you are experimenting with transmitting tubes, a heavy-duty low-voltage DC supply is needed for their filaments. Typical voltages range from 5 to 20 volts at up to 10 amperes. You can build such a supply from a surplus low-voltage, high-current transformer followed by a rectifier and filter capacitor. If you have a bench-top variac, you can use this to adjust the output voltage.

Regulated DC Supplies

If you can afford it, regulated power supplies are the best choice. They have low ripple (low hum), can maintain a steady output under load, and maintain that output accurately over time. Their main drawbacks are cost, complexity, and sometimes lack of ruggedness.

The explosion of computer technology has resulted in massive quantities of fixed-voltage modular supplies on the surplus market. These can be very useful for filament supplies. The most common voltage available is 5 volts, needed for TTL-compatible logic. These can be used as-is to run 300B filaments, for example. Many of them have enough "head-room" so that

they can be adjusted upwards to 6.3 volts. If, however, the output voltage abruptly drops as you adjust it above 5 volts, the supply has a "crowbar" circuit originally intended to protect logic from a power supply failure. This is typically an SCR (Silicon-Controlled-Rectifier) across the output - which can be removed.

One concern about computer power supplies is whether to use a linear or switching supply. A linear supply is the same as used in nearly all audio systems: a large laminated-iron power transformer followed by rectifiers, capacitors, and a regulating pass transistor. These are not very efficient and are heavy, but are inherently quiet. A switching regulator rectifies the power line directly, then uses sophisticated switching circuitry to convert the DC into high-frequency AC, which is then run through a small ferrite transformer and rectified again. Their main advantages are very good efficiency and light weight. They are complex and used to be expensive, however. If not filtered and well-shielded, switching supplies can spread their switching transients into sensitive circuits. Most modern supplies switch at over 20KHz, though, and I've heard several very good home-built sounding amplifiers that have used switching supplies for the heaters. One other point about switching supplies: most have very effective current-limiting to protect against destructive shorts. Since tube filaments can briefly draw up to four times their normal current when cold, switching supplies can shut down when trying to drive filaments. The only real solution is to use a supply that has at least 3 to 5 times the current rating of the tubes.

Bench-top low-voltage adjustable regulated DC supplies are a necessity for any solid-state work and even the all-tube

purist will find the occasional need for a DC filament or bias supply. Anyone working with op-amps will need a dual supply capable of + and - 15 volts or more with at least 200 mA current capability. Good quality low-voltage bench-top supplies are hard to find cheap in surplus, due to their universal usefulness. Expect to pay at least \$50 or more. A new supply will run from \$75 to over \$300.

High voltage supplies (over 150 volts) are a different story. Many thousands were made during the vacuum tube era, and technicians who need high voltage today generally don't want a 40 year old tube-type boat anchor. That leaves lots for us tube-o-philes! These old vacuum tube regulated supplies generally put out 400 to 500 volts at from 100 to 500 mA, although I have picked up an old Dressen-Barnes supply that was rated at 0-1000 volts at 500mA! These supplies nearly always have an unregulated 6.3VAC output for running tube filaments and some have a very low current (< 5mA) negative 0-100V output that was intended as a tube bias supply.

The common brands seen for tube power supplies are: Lambda, Kepco, Dressen-Barnes, Oregon Electric, Heathkit, EICO, Fluke, Hewlett-Packard, as well as many minor brands. Bringing up and restoring an old power supply is similar to restoring an old power amp: check the tubes, re-form or replace the electrolytics, replace tubular paper capacitors, replace any selenium rectifiers with silicon, and check for burned resistors or other damage. Aside from burned-out transformers it's not hard to get these supplies working.

Be careful! - Deadly voltages and currents are present in this equipment! Discharge all filter capacitors before working on the circuit and never solder or make changes with the power cord plugged-in!

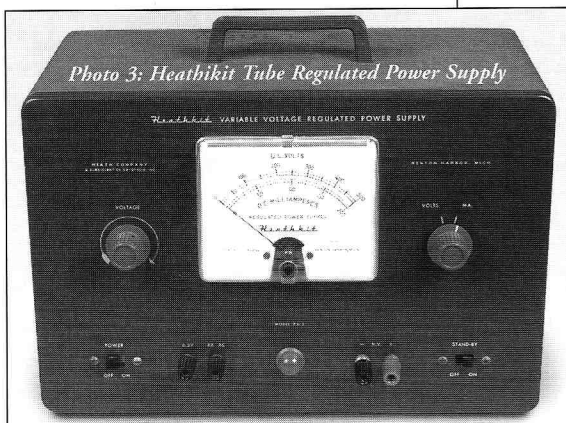

Photo 3: Heathkit Tube Regulated Power Supply



Photo 4: Lambda Model 50 Regulated Power Supply

Photo 4 shows an incredibly heavy Lambda Model 50 bench-top supply. Lambda also made a line of narrow rack-mount supplies that are also amazingly heavy. Photo 3 shows a PS-3 Heathkit regulated power supply, very common and usually easy to find at swap-meets, etc.

Specialty Supplies

Occasionally you will come across some odd-ball tube-type power supplies. These can be useful, depending on your interests. You may see a "Constant-Current" supply. These appears similar to conventional tube-type but will have a "maximum voltage" or "limiting voltage" control. These supplies have a high-impedance output that supply constant current. The limiting voltage control is analogous to a current-limiting control – it limits the maximum output voltage in this case. These are not especially useful for powering regular circuits, but are ideal for powering an incremental inductance bridge, something any transformer or choke person will be interested in.

Sometimes you will see high voltage supplies that go up to 2,000, 5,000, or even 30,000 volts! If these can fit on your test bench then they are too low in current for a transmitting tube amp project. Anyone experimenting with electrostatic speakers may find these handy, though. The high-voltage safety warning is especially important with these supplies. Use extreme care!

Capacitor Forming

Aside from powering prototype circuits, an adjustable high-voltage supply is invaluable for re-forming old electrolytic capacitors. As mentioned earlier, using a variac is not the best way to re-form the capacitors. Some capacitor checkers, such as the Sprague Tel-Ohmike, provide a current-limited voltage for re-forming. However, a DC bench supply also works very well and can provide feedback to you on how the forming process is going. First, a little capacitor theory.

An electrolytic capacitor is made up of two layers of aluminum foil separated by paper saturated by an electrolytic paste or jelly. When initially manufactured, there is no insulation present. Part of the manufacturing process is to slowly apply a DC voltage across the capacitor. The resulting current causes a microscopic layer of aluminum oxide to form, similar to the way aluminum is anodized. The thinness of this layer is what give electrolytics their high capacity density. The problem with electrolytics is best explained by Brotherton in his small but excellent book, *Capacitors* (p. 62; see reference 1):

"Unlike the dielectric in other capacitor types, the film is subject to deterioration in spots where foil impurities are present, when the capacitor is stored for long periods. When full voltage is again applied, leakage currents at these spots may be large enough to destroy the weakened film before it can be repaired by electrolytic action. Consequently, it is inadvisable initially to apply full-rated voltage to a capacitor which has been at zero voltage for many months. Also, since heat accelerates deterioration of the film, this precaution becomes particularly important when the capacitor has been stored in the tropics or other hot places. Electrolytic capacitors give most satisfactory service under continuous operating conditions."

This was written in 1946, and even by the 1950s electrolytics had improved enough that the time before reforming is necessary is usually years, not months. The easiest method of re-forming filter capacitors is to connect the positive lead of an adjustable supply to the rectifier output (or the first capacitor in the filtering chain) and the negative lead to ground. This allows all the capacitors in the filtering network to re-form together. With an eye on the current meter, slowly bring the voltage up from zero. You will see the current jump up and then fall back down – this is normal and is just the capacitor charging current. What you are looking for is the steady current. If it is higher than 5 to 10 mA, then back off the voltage. You will then see the current slowly decline – this is the forming taking place. Once the current has declined to less than 5 mA, crank up the voltage a bit more, and continue this process until you have reached the lowest rated voltage in the filter chain. On severely unformed capacitors, this process can take several hours, but more commonly it can be done in 5 to 10 minutes. If the capacitors had already been formed, you may not see any residual current at all. If you don't want to babysit the forming process, you can put a current-limiting resistor in series with the power supply, say 47K. You then wait for the voltage across the resistor to equalize.

Things to look out for in the forming process include isolated capacitors and shunt resistors. An example of an isolated capacitor is an electrolytic at the output of a tube regulator. With the unit powered-off, the voltage from the main power supply won't reach this capacitor. You will have to form it separately. If there are resistors from the B+ to ground, such as bleeder resistors or screen bias networks,

there will be a steady current draw that linearly increases with voltage which can confuse the re-forming process. If this is a problem, you may want to temporarily disconnect one end of the capacitor from the circuit while forming it. Gas tube regulators will cause a sudden jump in current – these can be removed if needed.

Occasionally you come across a capacitor that either doesn't capacitance – no charging current whatsoever, or one that never seems to form. Also, you may see signs of previous leakage: cracks in the rubber seal or dried up white crusty material. In all these cases, replacement is necessary. However, in most cases, if carefully done, even very old capacitors can be brought back to life.

References:

1. **Capacitors – Their Use in Electronic Circuits**, M. Brotherton, D. Van Nostrand Co., 1946. (A very practical book on capacitors by a member of the Bell Labs technical staff. Doesn't cover new types like plastic film or Hi-K ceramic types, though.)
2. **Electrolytic Capacitors**, P. McKnight Deely, Cornell Dubilier Corp., 1938. (A bit dated, but exhaustive treatment on electrolytic manufacturing and use.)
3. **Electronics – Experimental Techniques**, McGraw-Hill Book Co., 1949, W.C. Elmore, M. Sands, (Book 1 of Division V (Los Alamos) of the National Nuclear Energy Series. Chapter 7 has good regulated supply theory plus many circuits well-explained.)
4. **Electronic Instruments**, I.A. Greenwood, J.V. Holdam, D. Macrae, McGraw-Hill Book Co., 1948. (Book 21 in the famous MIT Rad-Lab series; chapters 15 and 16 have an excellent description of reference elements and tube regulator design.)
5. **DC Power Supply Handbook** (Application Note 90), Hewlett-Packard, Harrison Division, 1967. (A good treatment of solid-state linear power supplies.)
6. **Kepeco Power Supply Handbook**, P. Birman, Kepeco, Inc., 1965. (Kepeco's view on solid-state and hybrid supplies. Good practical information.)

Next Audio Test Bench: Impedance bridges and component measurement.

Fast Recovery Epitaxial Diodes

By Charles Kittleson
and Eric Barbour

© 1999 All Rights Reserved

Most power supplies in tube audio equipment use conventional diffused-junction P-N type silicon diodes. Silicon diodes are cheap and compact, but can sound awful due to their slow switching time and resultant tendency to generate noisy current spikes.

OEMs started using silicon diodes in the late 1950s and early 1960s, when the prices of decent high-voltage units became competitive with rectifier tubes. Silicon rectifiers were most often used in receivers, integrated amps, preamps and some power amps. Fisher, EICO, Heathkit, McIntosh and Marantz were some of the first companies to utilize solid-state rectifiers. This way, they would dispense with the rectifier tube, which required another filament winding on the power transformer. And even today, many tube guitar amps and high-end tube components still depend on low-cost silicon rectifiers of the 1N400X family.

Silicon diodes can sound bad because they generate switching noise from their slow switching time in comparison to tube rectifiers. There are actually two sources of noise: the reverse-recovery time and the turn-on spike. (see next article) This slow recovery time has always been an issue with regular silicon (or germanium, for that matter) rectifiers.

Because they are usually fed directly into a large reservoir filter capacitor in the power supply, rectifiers have to supply large current peaks once every AC line voltage cycle. These peaks occur 100 or 120 times per second and can be VERY large, and very "spiky". If heavy filtering and shielding are not used in the equipment design (and they rarely are), considerable RFI (with a rich harmonic content) from both these sources can be coupled into the audio signal path, and even back into the AC line, to be coupled into other electronics. Even if you put a resistor directly between the rectifier output and the first filter capacitor, to help decrease those current peaks, peaking and noise will still be present. And, the DC regulation of the supply will be impacted negatively.

A quieter alternative is the Schottky Barrier Diode. Unfortunately, Schottky diodes suffer from a few disadvantages, such as high reverse leakage currents compared to regular diodes. Schottkys are also very limited in the peak-inverse voltages they can handle. Nevertheless, for low-voltage supply rectifier applications, Schottkys are outstanding performers, widely used in the output sections of computer-type switching supplies. They can also be used with success in filament and low-voltage bias supplies in tube equipment.

What if the application requires higher voltages? Fast Recovery Epitaxial Diodes (FREDs) were developed initially by International Rectifier, in the early 1980s. Tube electronics were not the intended application, as high-frequency switching power supplies were just starting to become popular, forcing component manufacturers to develop faster and more efficient devices. IR's trade name was

HEXFRED. Now, several manufacturers make FREDs, including IR, Harris, IXYS, General Semiconductor, etc.

How Do They Sound?

When substituted into an amplifier, compared to silicon diodes, FREDs have a full and airy sound. The bass is tightened up, and the harsh edge in the mids and highs almost disappears. Details in the music start to come out with greater clarity than ever before. FREDs sound as close to a tube rectifier as one can get, while not requiring additional power to run a filament or heater.

Don't go out and replace your tube rectifiers with FREDs,

because tube rectifiers still have a sonic edge. Solid-state diodes also raise the B+ voltage. In addition, the mod may negatively impact the collectability of your gear. Good vintage hi-fi candidates for upgrading to FREDs include: Fisher 400, 500, 800 receivers, Fisher tube integrated amps with silicon rectifiers, EICO HF87 and HF89, Harman-Kardon Citation II and V, H. H. Scott 340B receivers, Sherwood integrated amps and receivers, McIntosh amplifiers, preamps and tuners, Marantz amplifiers and preamps, etc. Heck, they will even make most of your solid-state gear sound much better!

FREDs normally come in 600 and 1200 volt ratings and current ratings of one to 30 amps. Typically, diode peak-inverse-voltage ratings should be at least twice the DC supply voltage, because the rectifiers have to handle both positive and negative AC voltage peaks. Example: if the circuit will produce an operating voltage of 250 volts DC, it would require a FRED with a minimum of 500 volts rating. Be conservative, as there is the added possibility of occasional line-voltage spikes.

You can use FREDs in bias, B+ and filament supplies. However, a more economical approach in filament supplies would be to use Schottky diodes instead. Schottkys are inexpensive compared to FREDs and give excellent performance as power-supply rectifiers, if low voltages are involved. Schottkys are usually limited to 60V PIV ratings.

Even though they are far more expensive than ten-cent 1N4007 diodes, installing FREDs in your power supply can improve the sound of your system to a greater degree than exotic cables or other tweaks.

The Problems with Silicon Rectifiers

By John Atwood,
Technical Editor © 1999

When a conventional p-n junction rectifier is forward-biased (conducting current), many minority carriers (holes) are present in the n-silicon, just outside the junction. When the voltage across the junction is reversed, these holes must be swept out of the junction area before the rectifier will stop conducting. The result is an abrupt surge in current caused by the stored charge which then tapers down as the holes diffuse out of the junction

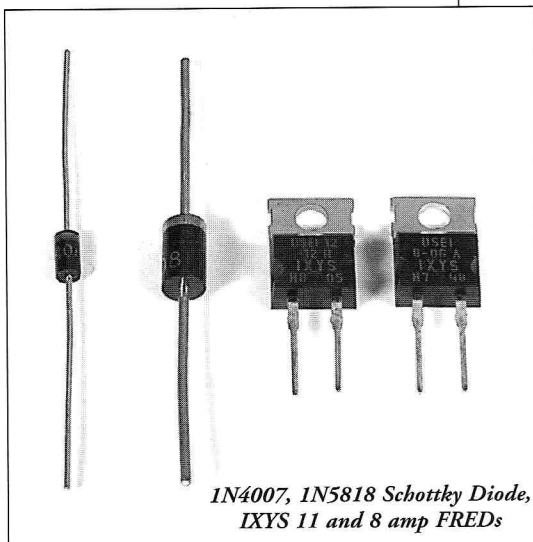

1N4007, 1N5818 Schottky Diode,
IXYS 11 and 8 amp FREDs

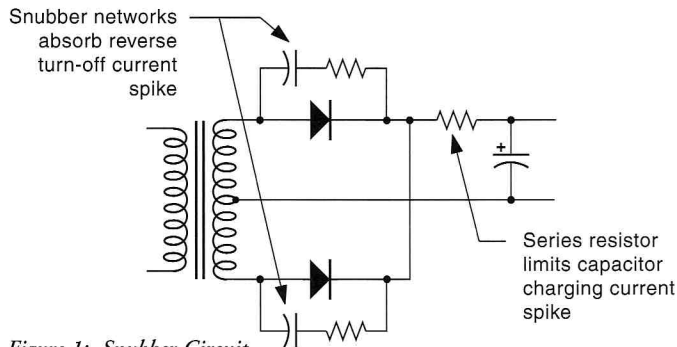

Figure 1: Snubber Circuit

crystal. This reduces the decay time and reduces the energy in the reverse current pulse. This technique is called "gold-doping" and is used in "fast-recovery" rectifiers.

parasitic capacitance and inductance – and ultimately by electron transit times.

If silicon rectifiers have to be used, adding snubber networks across the rectifiers will absorb nearly all the reverse current surge. A simple capacitor across the rectifier will smooth out the current surge, but not as effectively as the R-C combination. (See figure 1)

The reverse current spike is not to be confused with the forward-current spike ("turn-on" spike) in capacitor-input rectifier circuits. This spike is simply the result of trying to charge a large capacitor quickly and happens regardless of the rectifier type. It is solely dependent on the size of the capacitor and any series resistance in the circuit. Adding extra series resistance helps reduce this type of current spike.

area. This current spike contains a large amount of high-frequency energy. This can shock-excite any parasitic tuned circuits in the transformer or wiring. All this high-frequency energy can get into sensitive circuitry. This problem is most acute when the rectifier is drawing current especially troublesome in choke-input circuits.

There are three main ways of reducing the rectifier switching transient. One is to reduce the hole life-time by adding "recombination centers" in the silicon

The second technique is to use a rectification process that does not use any minority carriers that linger in the junction. The metal-semiconductor junction in a Schottky has no minority carriers, thus is inherently fast and low in noise. The HEXFRED and similar rectifiers use a structure based on a power MOSFET – again a system that uses no minority carriers.

The third technique is to use a technology where minority carriers don't even exist: vacuum tubes! Tubes are inherently fast – their speed is limited mainly by

References:

1. **Application of Fast Recovery Rectifiers**, General Electric Application Note 200.38, J.H. Galloway, June, 1965.
2. **Transistor Engineering**, A.B. Phillips, McGraw-Hill, 1962, pp. 145-148

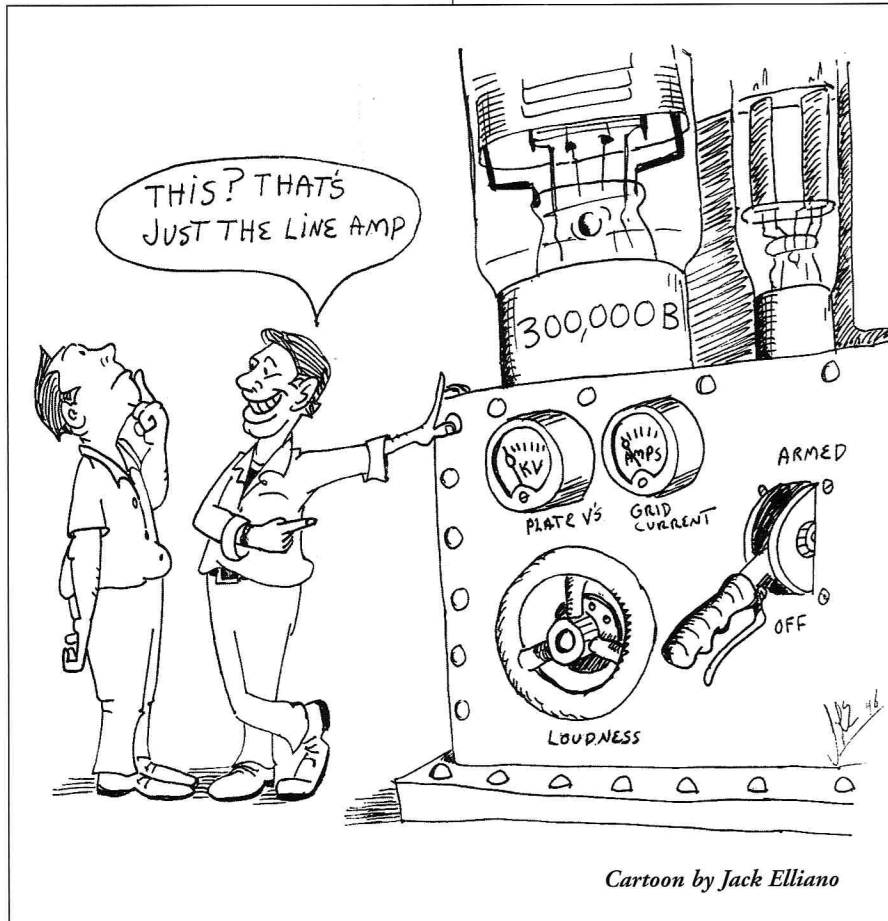

Cartoon by Jack Elliano



Big Tone™

VACUUM TUBE VALLEY
SUNNYVALE, CALIF. U.S.A.

Be the first in your neighborhood to have the official VTV "BIG TONE" T-shirt.

2 color heart print available in either **Blue Spruce** or **Burgundy**

Only \$14.50. plus \$3.00 postage US, CA residents add \$1.12 Sales Tax
Canada and Mexico add \$7.00 postage
Europe and Asia add \$12.00 postage

Cash, Check or Money Order
Credit Cards OK

Vacuum Tube Valley
P.O. Box 691
Belmont, California 94002 USA

VTV Pro-Tube Shop

Your headquarters for high quality audio parts & tubes
P.O. Box 691, Belmont, CA 94002 USA (Order 10am to 6pm Tue-Sat)
(650) 631-6550-Phone (650) 654-2065 FAX www.vacuumtube.com

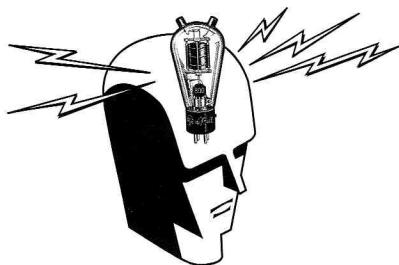

Order: By email, FAX, Mail, Phone
Minimum Shipping and Handling per order:
 US \$5.00, Canada \$10, Europe \$20, Asia \$25 (Heavier items will require additional postage)
\$35 Minimum Order

Vintage Hi-Fi Rebuild Kits Get Great Sound & Save Bucks!

All kits include all new ICMWR signal and bypass film caps, *under-chassis* electrolytics, 1 watt metal oxide low-noise plate resistors, new silicon power supply diodes and schematic. **Kits do not include FP can-type electrolytics.**

- Dynaco PAS2/3 \$45
- Dynaco Mark III \$40 (for pair)
- Dynaco Mark IV \$40 (for pair)
- Dynaco SCA-35 \$25
- Dynaco ST-35 \$25
- Dynaco ST-70 \$25
- EICO HF81 \$55
- EICO HF85 \$45
- EICO HF86 \$35
- EICO HF87, HF89 \$50
- Fisher X-101, X-202, etc \$55
- Fisher 400 Receiver \$60
- Fisher 500C Receiver \$60
- Fisher 800B, 800C \$60
- McIntosh MC30, MC40, MC75 \$45 ea
- McIntosh MC60 \$50 ea
- McIntosh MC225, 240 \$65
- McIntosh MC275 \$75
- Scott 130 \$80
- Scott 222, 222B, 222C, D \$55
- Scott 299, 299B, 299C, D \$55
- Scott 340B Receiver \$65

Illinois Capacitors

ICMWR Metallized Polyester
 (630Vdc rating)

0.001uf	\$0.80 ea
0.002uf	\$0.80 ea
0.0047uf	\$0.80 ea
0.0068uf	\$0.80 ea
0.01uf	\$0.90 ea
0.022uf	\$0.90 ea
0.047uf	\$1.00 ea
0.068uf	\$1.20 ea
0.1uf	\$1.30 ea
0.22uf	\$1.60 ea
0.47uf	\$2.20 ea
1.0 uf (400V)	\$2.50 ea
2.2uf (250V)	\$2.75 ea
3.3uf (250V)	\$3.20 ea
4.7 uf (250V)	\$3.80 ea
6.8uf (250V)	\$4.20 ea

Ultra-Tone Silver Foil in Paper and Oil Capacitors

98% pure silver foil in kraft paper impregnated with non-toxic mineral oil and petroleum jelly, sealed in epoxy. Silver plated OFC leads with inner foil marked (650Vdc rating)

0.01uf	\$12.00 ea
0.02uf	\$14.00 ea
0.05uf	\$16.00 ea
0.1uf	\$19.00 ea
0.22uf	\$28.00 ea
0.47uf	\$40.00 ea
1.0uf	\$70.00 ea
2.0uf	\$130.00 ea

*Ultra-Tone Silver capacitors are superb performers. Our customers think they are the smoothest, **best-sounding** and **most musical** capacitors available.*

Ultra-Tone Polypropylene Film & Foil Power Supply Capacitors (Not Silver Foil)

20uf @ 650V	\$20.00 ea
50uf @650V	\$40.00 ea
100 uf @650V	\$60.00 ea

FREDS (Fast Recovery Diodes)

IXYS 600V 8A	\$3.50 ea
IXYS 1200V 11A	\$6.50 ea
60V 5 Amp Schottky	\$1.50 ea

Illinois Axial Electrolytic Capacitors

Great Value and very dependable.

3.3uf @350V	\$1.20 ea
4.7uf @350V	\$1.45 ea
10uf @450V	\$1.60 ea
22uf @250V	\$1.95 ea
22uf @450V	\$2.25 ea
22uf @500V	\$2.85 ea
47uf @35V	\$1.50 ea
47uf @350V	\$2.50 ea
47uf @450V	\$3.45 ea
100uf @160V	\$2.95 ea
100uf @350V	\$3.90 ea
100uf @450V	\$4.90 ea
1000uf @25V	\$1.75 ea
2200uf @35V	\$2.75 ea

Hovland MusiCaps Polypropylene Foil and Film

High resolution, great-sounding film caps perfect for all types of audio equipment upgrades.

0.01uf @1600V	\$9.79 ea
0.022uf@1000V	\$9.82 ea
0.033uf @600V	\$8.01 ea
0.047uf @1KV	\$12.05 ea
0.1uf @600V	\$11.52 ea
0.22uf @600V	\$14.55 ea
0.47uf @400V	\$12.80 ea
0.47uf @600V	\$21.71 ea
1.00uf @400V	\$21.66 ea
2.2uf @200V	\$23.83 ea
3.0uf @200V	\$28.45 ea

Note: Only the above Hovland values in stock.

Tube Sockets

Octal Ceramic Chassis	\$3.50
Octal Ceramic PC mt	\$3.00
Octal NOS Phenolic	\$3.50
9 Pin Ceramic PC	\$2.50
9 Pin Ceramic Chassis	\$3.00
9 Pin Ceramic GOLD	\$5.00
9 Pin Plastic w/shield	\$4.00
9 Pin NOS Brn Phenolic	\$3.00

Order Fast from our on-line catalog
www.vacuumtube.com

Can Electrolytic Capacitors

20,20,20,20 @475V
 (Mallory type) \$29.00

50+50uf @500V LCR w/clamp \$21.50

100,100uf @500V
 LCR w/clamp \$28.00

40,20,20,20uf @500V,
 LCR w/clamp \$32.00

D.H.Labs Silver Sonic Wire

Rated as the best sounding wire for the money by several audio publications.

"This is nothing other than a superb cable. It can be used with confidence with the finest of systems."

Make your own speaker cable & interconnects.

Save BIG!!!

Silver Sonic T-14
 Speaker Wire \$4.00/ft

Silver Sonic BL-1 High Definition Interconnect Wire \$3.50/ft

Silver Sonic OFH-20 High Performance Silver/Teflon Chassis Wire \$0.95/ft

RCA-2 Gold Tiffany-Style Interconnect Plug \$10.95ea

B-1C Gold Banana Plug and Insulator \$5.50/pr

BSP Gold Mini Spade Speaker Terminals for Vintage Hi-Fi \$1.10 ea

AMEX, VISA, MC OK

Send \$3.00/US, \$4.00/US\$ Foreign for our 24 page informative catalog with cool NOS tubes parts and Vintage Hi-Fi. VTV Pro-Tube Shop, P.O. Box 691, Belmont, CA 94002 USA



ELECTRA-PRINT AUDIO

QUALITY HANDWOUND S.E. OUTPUT TRANSFORMERS

- Primaries from 1.8K to 10K
- Exclusive wideband design
- 16, 8, 4, or 2 ohm secondary
- Gold plating

CUSTOM-BUILT POWER TRANSFORMERS/CHOKES

- Wound to your requirements
- Heavy-duty design for Class A use
- DC filament supply windings
- HV chokes to 15H, 300ma
- Low voltage, high current filament chokes

Component pricing and specifications catalog available

ELECTRA-PRINT AUDIO

4117 Roxanne Drive Las Vegas, NV 89108
702-396-4909 FAX 702-396-4910

one electron™

Single-Ended Output Transformers

High Quality for a Reasonable Price
Designed and Built in the USA

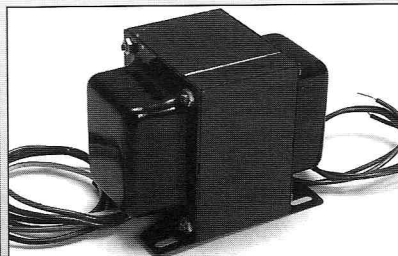

UBT-1 Designed for parallel operation of:

1.6k primary 15 watts 160 mA **\$99.00** 2A3s, EL34s, 300Bs 6AS7s, etc. or Sweep-tube in "enhanced triode" mode

UBT-2

4.8k primary 15 watts 110 mA **\$119.00** Can be used with: 300B, 50, SV811-3, etc.

UBT-3

3k primary 15 watts 110 mA **\$119.00** Good for single ended 2A3 or 300B

Quantity discounts available

ANTIQUE ELECTRONIC SUPPLY™

6221 S. Maple Ave. • Tempe, AZ • 85283

Phone (480) 820-5411 • FAX (480) 820-4643 or 800 706-6789

AFFORDABLE HAND-WIRED GUITAR AMP KITS!



Available
with Jensen
speakers!

Based on blackface era amps from the mid 60s, these all-tube guitar amps feature 3-knob reverb control, tube rectifier, solid-pine jointed cabinets, bias setting jacks, master volume control, heavy aluminum chassis, cloth covered wiring, full size potentiometers, vintage style tube sockets, 40W 2x6L6 output, carbon composition resistors, Mallory tone capacitors and many other top features.

2x12 TONESavor \$799 2x10 Old Flame \$749

ALLEN

AMPLIFICATION

Quality tube amps,
kits and parts

Phone: (606) 485-6423

Fax: (606) 485-6424

E-Mail: tonesavor@fuse.net

www.iguitar.com/allen



Moth Audio Corporation

HYPER DAC

24 / 96 with HDCD

Stereo Digital to Analog Converter

Three digital inputs, AES/EBU, S/PDIF and TosLink
With vacuum tube output circuitry. **\$2100.00**

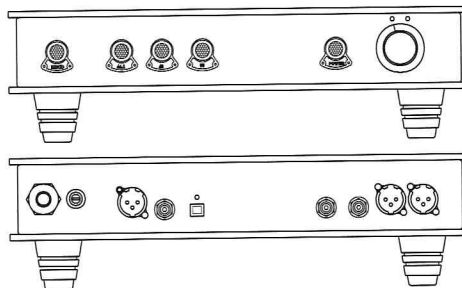

1746 Ivar Ave. Hollywood CA 90028

323 HOLLYWOOD 7-4300

fax 323 464-9100

web www.mothaudio.com

Maxi-Matcher Digital Tube Tester

Vacuum Tube Testing and Matching System

- Instantly identify weak or blown tubes
- Quickly measure tubes for amplifying capability
- Precision-match tubes for plate current and/or transconductance
- Save money on third-party matching costs
- Increase sales of matched sets by verifying customers tubes
- Incoming QA check for OEMs or music stores
- Create your own label tube sets

The Maxi-Matcher Digital Tube Tester measures any of the standard octal-base power pentodes for Plate Current (I_p) and Transconductance (G_m) characteristics, and with optional adaptors will also test nine-pin pentodes, Novar power pentodes, 7591's, and some power triodes and power tetrodes.

The test set measures up to four tubes at a time, and has a separate test socket for short circuit testing. Separate selector switches for Bias voltage, Plate voltage, Measurement Function, and Test Socket Select are provided, along with protection fuses, indicators and a mains switch. All measurement data appear on a large 3.5 digit LED display.

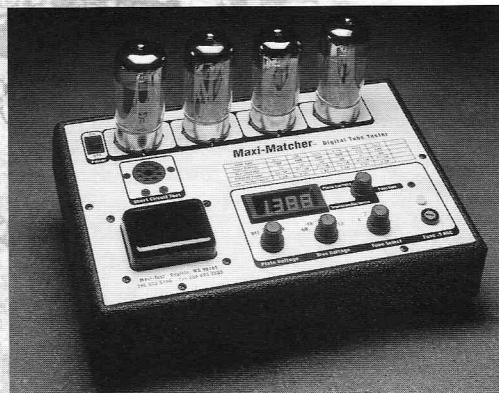

Maxi-Test Company

@ Condor Electronics

125 North 36th Street

Seattle WA 98103

206 633 5190 206 633 0803 fax

thetubestore.com

Your online source for name brand audio tubes

Enjoy the convenience of purchasing audio tubes at our secure online webstore. We stock a wide range of products including Ei, Tesla/JJ, Svetlana, Sovtek, Sino, and JAN.

Competitive prices and fast service.

Check out the selection at thetubestore.com

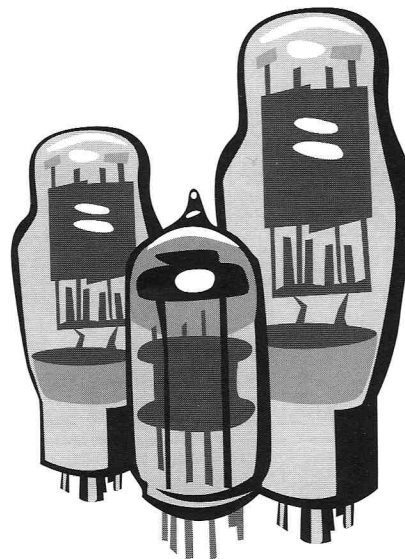

It's Like Music to Your Ears...

Amperex Bugle Boy

audio tubes are back and they're better than ever!

When it comes to selecting premium audio tubes for your amplifier, accept no less than the best, Amperex Bugle Boy! Amperex Bugle Boy tubes are burned in under full load with all voltages applied for 24 hours before being tested for noise & microphonics. The aging racks used are from the original Amperex production line built in Holland decades ago.

Complete test results are supplied with each tube, including plate current, screen current, filament current, and total harmonic distortion (THD). The THD measurement is performed using one of the finest spectrum analyzers available – the Hewlett Packard 3561A. Matching in pairs, quartets & octets is available for all tube types.

Special test requirements? Not a problem. For a slight additional charge we will test and match to your specified operating conditions.

Types available: **6DJ8/ECC88**, **12AU7A/ECC82**, **12AX7A/ECC83** and many more!

So if you haven't dealt with a source capable of meeting your demands, call us at **1-800-TUBE USA** or **630-208-2200** today for information on additional products and the worldwide locations nearest to you. You'll like what you hear!

APD is pleased to announce the addition of **Hammond Manufacturing's** complete line of Classic Transformers and Enclosures to our product offering. Call today for a Hammond catalog or download it from our WEB site at www.tubes-r-us.com/classic.html.

BLUENOTE Midas Dampers are now available, along with other quality audio accessories - such as, equipment isolators and CD/LP treatments. The Midas Dampers (as reviewed in *Stereophile Magazine*, February, 1996) are made of the highest quality materials available. They reduce microphonics in your preamp tubes thereby enhancing the music you hear.

Call **1-800-TUBE USA** or **1-800-882-3872** today for your copy of our **NEW APD brochure** featuring Audio Tubes, **BLUENOTE** and Hammond products .

APD Audio Product Division

a division of Richardson Electronics, Ltd.

40W267 Keslinger Road
P.O. Box 393
LaFox, IL 60147-0393
(630) 208-2200
(800) 882-3872

 **Richardson
Electronics**

Engineered Solutions

You can also visit our Classic Components site on the Internet at:
www.tubes-r-us.com

VACUUM TUBE VALLEY

Back Issues, Books, Goodies, & Subscriptions



VTV #1 Spring 1995 \$8 US - \$10 Foreign
Vintage Dynaco Tube Equipment - 1955-77
History and Testing of the 12AX7/ECC83 dual triode
Tube Testing Methods + Early Amplification and Amps

VTV #2 Fall 1995 \$12 US - \$15 Foreign
Heathkit - The Tube Williamson Years 1950-61
EL34/6CA7 History, Types and Tests
Magnum SE EL509 Amplifier Project by Dave Wolze
1927-34 Western Electric Theater Sound Systems

VTV #3 Winter 1995/96 \$12 US - \$15 Foreign
Eico Mono Tube Gear - 1955-62
Altec Lansing 604 Coaxial Loudspeaker History
Western Electric 300B History and Listening Tests
300B SE Transformer Listening Tests

VTV #4 Spring 1996 \$12 US - \$15 Foreign
6L6 History, Types and Listening Tests
Vintage Bookshelf Speakers 1955-1965
Early FM Broadcasting History
HK Citation I & II Amplifier History and Mods

VTV #5 Fall 1996 \$12 US - \$15 Foreign
The Ultimate FM Tuner Shoot Out
Red Bank Guided Missile Tubes for Hi-Fi
The Birth of the Marantz 10B
Choosing Rectifier Tubes for your Guitar Amplifier

VTV #6 Winter 1997 \$12 US - \$15 Foreign
Fisher 500 - History, Models and Restoration
A Tribute to Avery Fisher by the Fisher Doctor
6550 and KT88 History, Types and Listening Tests
Loftin-White Amplifier History by Alan Douglas

VTV #7 Summer 1997 \$12 US - \$15 Foreign
6DJ8 & Frame Grid Tubes + Listening Tests
Altec 1950s Theater Amps and Modifications
The Great Voice - The Peter Jensen Story
Computing with Tubes - The Savage Art
Uncle Eric's Tube Dumpster - 417A/5842

VTV #8 Fall 1997 \$12 US - \$15 Foreign
EL84 History, Types & Listening Tests
RCA Tube Mfg at Harrison, New Jersey
200 watt OTL Amp Project by Allan Kimmel
300B Listening Tests: NOS and Vintage Types
Bruce Moore Tube Audio Pioneer

Vintage Hi-Fi Spotter's Guide-Volume 1
Over 450 photos & specifications of tube audio gear
from the Golden Age of Hi Fi. 86 pp. \$18.95

Vintage Hi-Fi Spotter's Guide Volume 2
Volume 2 covers equipment not listed in Volume 1.
Almost 500 amps, preamps, tuners, etc are depicted.
Edition covers early audio and includes a Speaker section
with most vintage manufacturers. 88 pp. \$18.95

Vintage Hi-Fi and Audio Price Guide 1999-2000
Updated price & grading guide for almost 1,000 vintage
hi fi amps, preamps and tuners. Includes Vintage pro
audio and theater gear. Also, pro loudspeakers, N.O.S.
vacuum tubes and audio transformers. \$20.00

"Vintage Hi-Fi The Golden Era Video"
A one-of-a kind video covering the classic post-war and
1950s home hi fi era. Over 80 classic audio amps, pre-
amps tuners, are shown. This video is professionally pro-
duced. 34 min VHS NTSC \$20.00

The Ultimate Tube Substitution Guide
No tube electronics enthusiast should be without this
book. Over 10,000 tubes are listed on 240 pages includ-
ing: audio, radio, transmitting, and special. Features an
audio tube section with tube evaluation. \$29.95

Vacuum Tube Valley T-Shirts Two Styles to Choose From!

- A) VTV Marching Tubes - "Big Tone"
1 sided available in Burgundy \$15.00 XL only
- B) VTV Tube Sunburst Shirt with 2-color black & orange
art as pictured plus large 2-color RCA tube diagram
exploded view on back. (Available in gray) \$20.00 XL only
- C) Official VTV Cap - High quality dark navy cap with silver
embroidered "Tube Head" on front. "Vacuum Tube Valley"
stitched on back. Velcro size adjustment, 100% Cotton \$20.00



VTV #9 Spring 1998 - Transmitting
Tube Review, Ampeg SVT Guitar Amp,
Altec 287W amp, Bargain Vintage Hi-Fi
\$12 US - \$15 Foreign

VTV #10 Summer/Fall 1998
Story of the 6V6, Hi-Fi radio in the 30s,
PP SV572 amp, Ultrathin Line Stage
\$12 US - \$15 Foreign

ORDER FORM

Name _____ Date _____

Address _____

City _____ State _____ Zip _____

Please Send Me The Following Products

_____ \$ _____

_____ \$ _____

_____ \$ _____

_____ \$ _____

_____ \$ _____

Credit Cards, U.S. Bank Checks or Money Orders OK

Credit Card # _____

Signature _____

Add \$5.00 Shipping per order in USA / Add \$10.00- Item Air Mail Foreign Shipping

CA Residents Add 8.25% State Sales Tax

(CA Tax)

TOTAL ORDER

Exp. Date _____

Subscribe To Vacuum Tube Valley The Classic Electronics Journal

\$36/year US - 4 issues \$43/Canada,
\$56/Europe & \$66/Asia & World

VACUUM TUBE VALLEY
P.O. Box 691
Belmont, California 94002 USA
Phone (650) 631-6550 FAX (650) 654-2065
email - triode@vacuumtube.com

www.vacuumtube.com

A LEGEND REBORN!

Enlarged, heavy gauge figured glass bottle handles higher temperatures, improving performance at higher power levels.

Extra thick premium quality star mica spacers (top and Bottom) improves performance stability and reduces adverse microphonics.

Precisely tensioned filaments for better mechanical stability and reduced adverse microphonics.

Deep swaged heavy grid rods made from pure copper provide improved mechanical support for grid windings.

Brite nickel beam focusing electrode concentrates the electron flow precisely on the plate for improved power output.

Heavy duty plates made from a special alloy are stiffened with ridges and coated for strength and durability.

Enlarged phenolic base provides excellent contact with glass envelope and insulation, preventing shorting between critical components.

All specifications equal or exceed the original Genelex Gold Lion KT66 standards.

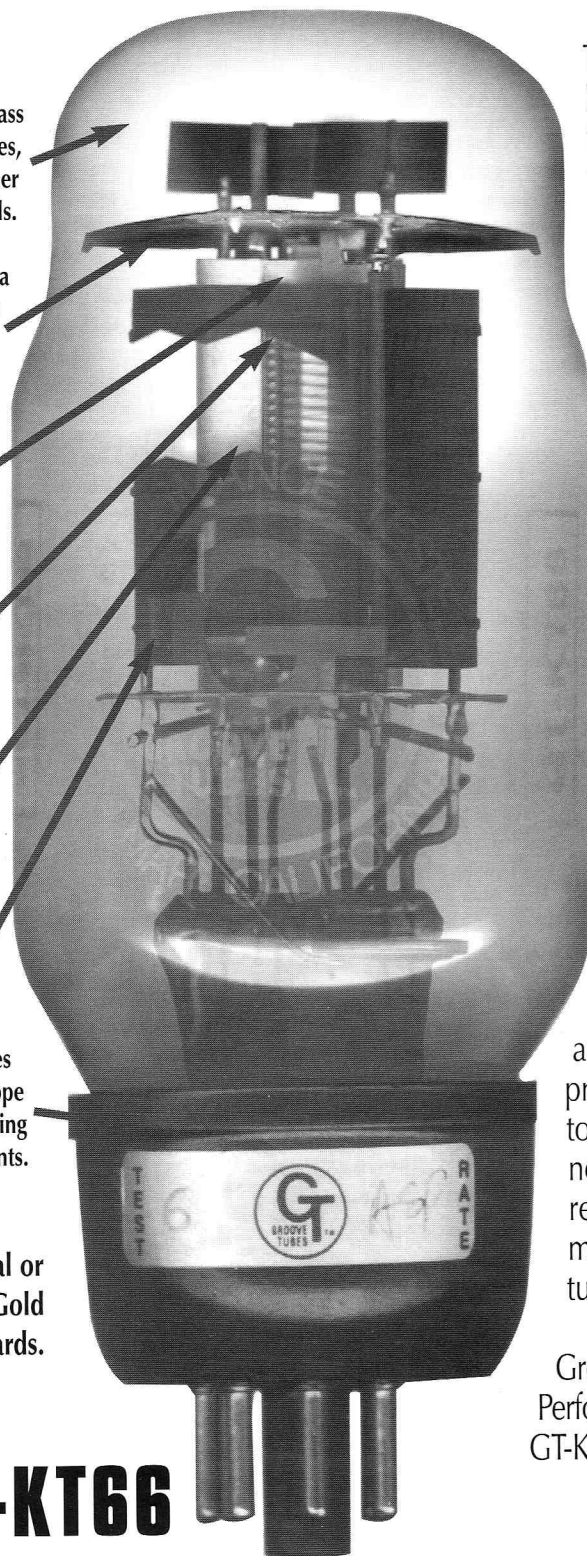

The legendary British made KT66 is one of the most famous tubes of all time. In the 60's it powered other British legends like Quad Hi Fi amps and the first Marshall guitar amps. This tube was the sound of Eric Clapton on the classic John Mayall Bluesbreakers album.

If you can even find an original KT66 today, they'll set you back up to \$300 apiece.

Groove Tubes has given new life to this legend, creating our own tooling to manufacture it again. We were able to keep the sound and improve on the tube in satisfying ways.

With our precision tooling and modern manufacturing processes, we consistently hold tolerances the 60's original could never attain. Insights from our research allows us to control musical parameters no other tube maker even knows about.

Groove Tubes is offering Performance Matched Duets of the GT-KT66R @ \$120 (U.S. retail price).

THE GT-KT66



Groove Tubes... *The American Tube Company, since 1979.*

12866 Foothill Blvd., Sylmar California 91342 USA

Tel: (818) 361-4500 • Fax: (818) 365-9884 • www.groovetubes.com

Purveyors of "Classic" Transformers & Enclosures

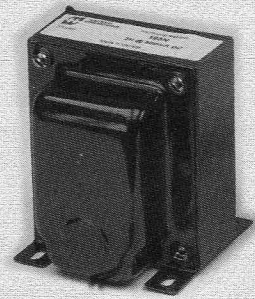
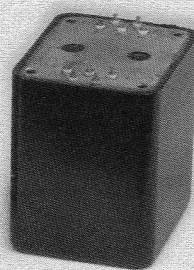
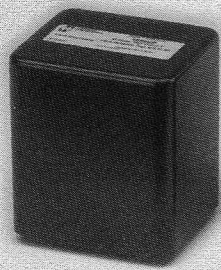
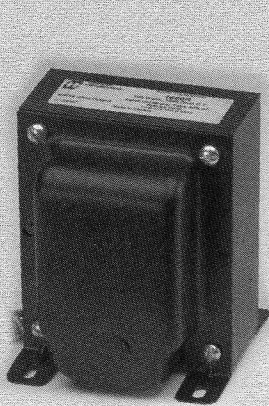

*Single Ended, Push-Pull
and Potted Tube Output
Transformers*

Filter Chokes

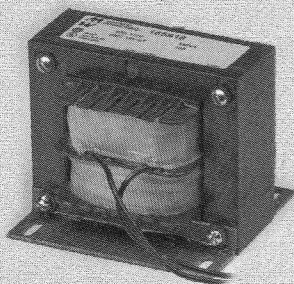

*Open & Enclosed
Filament Transformers*

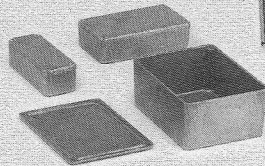

*Aluminum & Steel Chassis
and Diecast Aluminum
Enclosures*

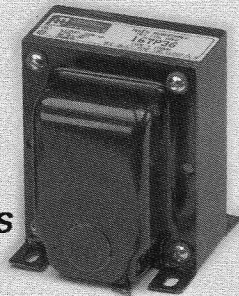

*High Voltage Plate
Transformers*

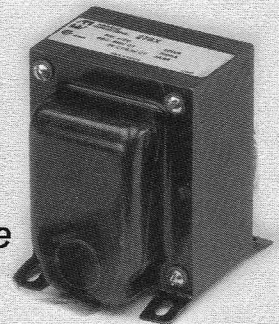

Contact us for a free catalog & list of stocking distributors

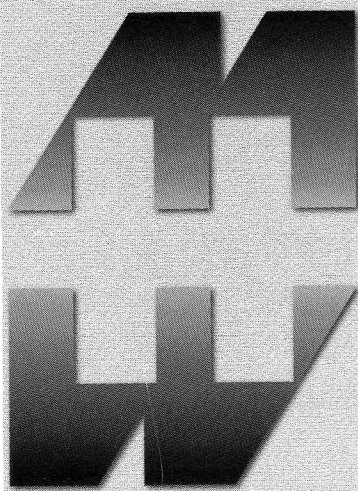

HAMMOND MANUFACTURING™

4700 Genesee St. - Cheektowaga, NY 14225 USA
Phone: (716) 631-5700 Fax: (716) 631-1156
394 Edinburgh Rd., N. - Guelph, Ontario N1H 1E5 Canada
Phone: (519) 822-2960 Fax: (519) 822-0715

www.hammondmfg.com



Products by:

- Allen Bradley
- Alps
- Caddock
- CAIG Labs
- Cardas
- DH Labs
- Elna Cerafine
- Hammond
- Holco
- Hovland MusiCaps
- Hubble
- Jensen
- Kimber Kable
- KR Enterprise
- LCR Caps
- Lowther
- Magnequest
- Mills
- MultiCap
- Neutrik
- Noble
- PFT Chassis
- Ram Labs
- Roederstein
- Solen
- Sorbothane
- Sovtek
- Svetlana
- Tesla
- Vampire
- WBT
- Wima
- and many more...

 **Welborne Labs**

P.O. Box 260198 Littleton, CO 80126 USA
 tel: 303.470.6585 fax: 303.791.5783

e-mail: wlabs@ix.netcom.com website: <http://www.welbornelabs.com>

Celebrating our 10th Anniversary 1988 - 1998

Our 1998 Catalog & Design Manual is now available featuring tons of kits, parts, books, software, schematics, fun projects and the usual info. It's just \$12 U.S. and Canada, \$18 International, refundable. Visa and Mastercard Welcome.

Electron Valve

**Your source for hard to find
 Vintage Audio Tubes
 and Quality Vacuum Tube
 Audio Components**

Stop by our website to see a detailed look at all of our products!
www.electron-valve.com • Email: info@electron-valve.com
 Phone: 901-382-9955 • Fax: 901-382-9956

We are a proud dealer of **Western Electric** Audio Products.
 The current production 300B is now in stock.



Electron Valve stocks a wide array of **NOS** Vintage Audio Tubes like Mullard EL34, RCA 2A3, and Mullard 5AR4. We also have a good stock of Old Production Western Electric tubes such as

205B/D, 252A, 274B, 300B and many others.

Electron Valve carries Precision Tested Ram Labs Reference Tubes. These tubes are computer tested, graded and matched to ultra high specifications predetermined by Roger A. Modjeski.



We also carry the Music Reference **MR** RM-10 (Push-Pull 6BQ5, 35W/Side) Stereo Amplifier and the Music Reference RM-200 (Push-Pull 6550, 100W/Side) Stereo Amplifier.

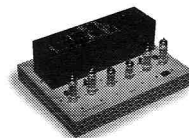

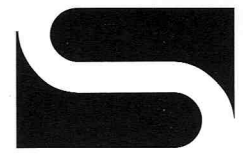
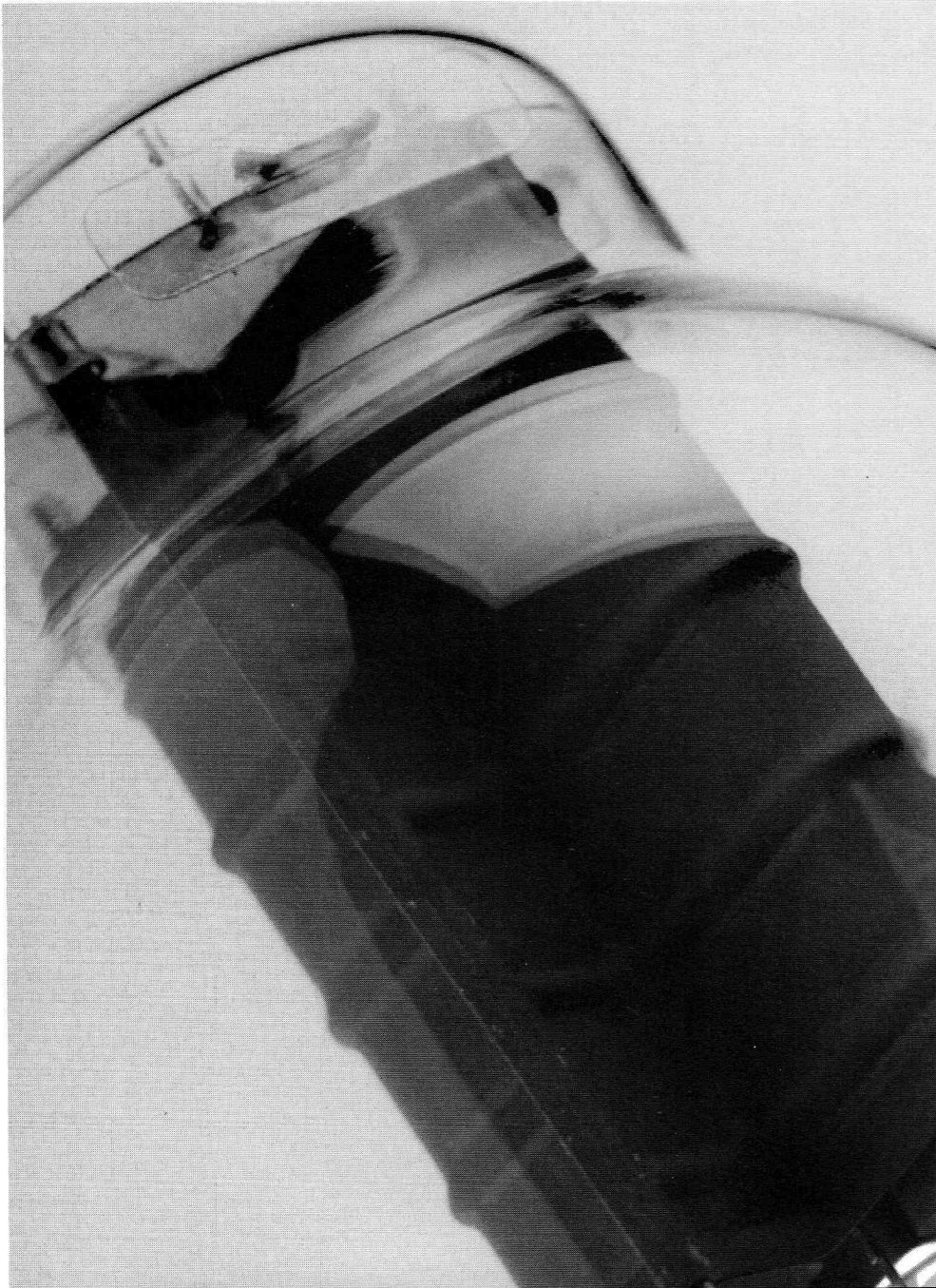

Svetlana
ELECTRON DEVICES

*They made it first but
we made it affordable!*

Svetlana is proud to introduce the SV300B power triode. Recreating the tonal qualities of the original, the SV300B sets a new standard of excellence. It is manufactured in Russia under Svetlana's stringent quality control and offers ultimate sound and appearance without the high price of the original. The SV300B is tested at the factory and matched into pairs, ensuring optimal performance and durability.

SV300B

For an early review of the Svetlana SV300Bs sound, see Vacuum Tube Valley magazine, issue 8, page 22-23.

Copyright 1998. Svetlana Electron Devices, Inc. All rights reserved.

8200 S. Memorial Parkway
Huntsville, AL 35802
256-882-1344 • Fax: 256-880-8077

3000 Alpine Road
Portola Valley, CA 94028
650-233-0429 • Fax: 650-233-0439

www.svetlana.com

"Deep Impact"



That's the effect our A-4 has on it's owners.

Fully Assembled \$559.00 ~ Kit \$449.00 ~ Chrome chassis add-on \$95.00

- 30 Watts Per Channel*
- Extremely Low Noise*
- Tubes: 4/12AU7 & 4/EL-34*
- Point To-Point Wiring*
- Exceptional Quality & Sound*
- Ultra Linear Push-Pull*

We carry other Amplifiers, Preamplifiers and Phono-Preamplifiers.
All kits come complete with step-by-step manuals, schematics and drawings.

Call For Your Free Catalog!

Antique Sound USA Made in the USA

6717 NE 181st Street, Kenmore, WA 98028 USA Phone 425-481-8866 Fax 425-485-3836
E-Mail: franklab@ix.netcom.com Web-site: www.amemura.com/sound/

Western Electric®
High Fidelity

WE300B

**The Standard In
Quality and
Long Life**



Matched Pair WE300B

Western Electric High Fidelity products are marketed worldwide by Westrex Corporation. Western Electric is a trademark of Lucent Technologies Inc., formerly AT&T Technologies, Inc., licensed to Westrex Corp., a company independent of Lucent. Developments of Bell Laboratories. Western Electric High Fidelity products are manufactured in the U.S.A.

Western Electric Audio Products

1230 Peachtree Street • Suite 3750 • Atlanta, GA 30309-3575 • (404) 874-4400 fax (404) 874-4415
e-mail: sales@westernelectric.com • internet: www.westernelectric.com

More Than Just Tubes

If You're Looking for that Special Mix of New and Vintage Components for a Special Project, There's a Good Chance We have Everything You Need under One Roof.

Tubes • Transformers
Capacitors • Resistors
Books • Videos • Knobs
Grill Cloth • Chokes
Filament Transformers
Tube Sockets • Project
Chassis • Soldering Tools
Switches • Speakers
Decals • Rebuild Kits
Replacement Dials • Test
Equipment • Meters
Spotters Guides
Reproduction Manuals
Paint • Tuning Capacitors
Hats • Shirts

More Hardware
Than You Would Believe

Phone (480) 820-5411 FAX (480) 820-4643 or (800) 706-6789

Visit our website at www.tubesandmore.com

ANTIQUE
ELECTRONIC
SUPPLY®

ELECTRON TUBE

Svetlana

RCA
Transmitting
Tubes

SYLVANIA
RADIO TUBE